

# Table of Contents

---

Safety Precautions .....	iii
Classification .....	iv
General Cleaning Tips .....	iv
Scrap Computer Recycling .....	vi
<b>SECTION 1 INTRODUCTION.....</b>	<b>1</b>
1.1    General Description .....	1
1.2    System Specifications .....	2
1.2.1    Main CPU Board .....	2
1.2.2    System I/O .....	3
1.3    Block Diagrams and Dimensions.....	7
1.4    Outlets .....	10
1.5    Packing List.....	12
1.6    Jumper Settings.....	15
1.6.1    Restore BIOS Optimal Defaults (JP3) .....	15
1.6.2    DELAY Function SW (JP5&JP6).....	15
1.7    Connectors .....	16
1.7.1    Remote Power Switch Connector (CN1) .....	17
1.7.2    SIM Card Slots (CN3、CN9).....	17
1.7.3    Audio Connector (CN4).....	17
1.7.4    VGA Connector (CN5) .....	18
1.7.5    HDMI Connector (CN6).....	18
1.7.6    M.2 3042/3050 Key B (CN7).....	19
1.7.7    USB 3.2 Connector (CN8、CN10).....	20
1.7.8    Full-Size PCI Express Mini Card Slot (CN11).....	21
1.7.9    M.2 2230 Key E Wi-Fi & Bluetooth (CN12).....	22
1.7.10    LAN Connector (CN13).....	23
1.7.11    DC-in Phoenix Power Connector (CN14) .....	24
1.7.12    SATA Power Connector (SCN2、SCN3、SCN4) .....	24
1.7.13    SATA Connector (SATA1~SATA2) .....	24
1.7.14    AT/ATX Power On/OFF Button (SW1).....	25
1.7.15    AT/ATX Switch (SSW1) .....	25
1.7.16    Flexible IO - COM I/O Card Connector (AX93511) .....	26
1.7.17    Flexible IO – Isolated COM & DIO I/O Card (AX93512).....	27
1.7.18    Flexible IO – Isolated COM x4 I/O Card (AX93516).....	30
1.7.19    Flexible IO – USB3.0 x2 & COM x2 (RS232/422/485) & LAN1 (AX93519) 31	
<b>SECTION 2 HARDWARE INSTALLATION .....</b>	<b>35</b>
2.1    Installing the Processor .....	35
2.2    Installing the Wi-Fi Module.....	37
2.3    Installing the 5G Module.....	38
2.4    Installing the Memory Module.....	40
2.5    Installing the Hard Disk Drive and NVMe SSD .....	42
2.6    Installing the PCIe Card and External Fan Module .....	45
2.6.1    Installing PCIe add-on card .....	45
2.6.2    Installing the External Fan Module .....	48
2.6.3    The limitation of an add-on card .....	50
2.7    Installing the foot pads.....	52
2.8    Wall mounting .....	53

<b>SECTION 3 AMI BIOS UTILITY .....</b>	<b>55</b>
<b>3.1 Starting .....</b>	<b>55</b>
<b>3.2 Navigation Keys .....</b>	<b>56</b>
<b>3.3 Main Menu .....</b>	<b>57</b>
<b>3.4 Advanced Menu .....</b>	<b>58</b>
<b>3.5 Chipset Menu .....</b>	<b>71</b>
<b>3.6 Security Menu .....</b>	<b>80</b>
<b>3.7 Boot Menu .....</b>	<b>81</b>
<b>3.8 Save &amp; Exit Menu .....</b>	<b>82</b>
<b>APPENDIX A WATCHDOG TIMER .....</b>	<b>85</b>
<b>A.1 About Watchdog Timer.....</b>	<b>85</b>
<b>A.2 Sample Program .....</b>	<b>85</b>
<b>APPENDIX B WAKE on LAN .....</b>	<b>89</b>
<b>How to Set up Wake on LAN.....</b>	<b>89</b>

## SECTION 1 INTRODUCTION



This chapter contains general information and detailed specifications of the . Chapter 1 includes the following sections:

- General Description
- System Specifications
- Dimensions
- I/O Outlets
- Jumper Settings
- Connectors
- Package List

### 1.1 General Description

The is an embedded system that supports the LGA1200 socket for Intel® Xeon and 10th generation Core™ i7/i5/i3 processors. The supports Windows® 10 and Linux, with a rugged design that makes it suitable for the most enduring operation.

- The provides three hard-drive bays and one M.2 Key M 2280 socket for customers to easily add storage and maintain the system.
- The supports Linux, Windows® 11, Windows® 10, and embedded OS.

## 1.2 System Specifications

### 1.2.1 Main CPU Board

- **CPU**

Socket LGA1200 for 10<sup>th</sup> Generation Intel® Core™ i7/i5/i3 and Xeon processors, up to 80W. CPU support is listed as below.

<b>Generation</b>	<b>Proc No</b>	<b>WATT</b>	<b>Core</b>	<b>Thread</b>	<b>Base frequency</b>	<b>Turbo frequency</b>
Cometlake	XeonW-1270TE	35W	8	16	2.0 GHz	4.4 GHz
Cometlake	XeonW-1250TE	35W	6	12	2.4 GHz	3.8 GHz
Cometlake	XeonW-1270E	80W	6	16	3.4 GHz	4.7 GHz
Cometlake	i7-10700E	65W	8	16	2.9 GHz	4.8 GHz
Cometlake	i7-10700TE	35W	8	16	2.0 GHz	4.4 GHz
Cometlake	i5-10500E	65W	6	12	3.1 GHz	4.2 GHz
Cometlake	i5-10500TE	35W	6	12	2.3 GHz	3.7 GHz
Cometlake	i3-10100E	65W	4	8	3.2 GHz	3.8 GHz
Cometlake	i3-10100TE	35W	4	8	2.3 GHz	3.6 GHz
Cometlake	G6400TE	35W	2	4	3.2 GHz	N/A

- **System Chipset**

- Intel® W480E chipset

- **BIOS**

- AMI BIOS

- **System Memory**

- Four DDR4-2933 MT/s ECC or non ECC U-DIMM socket max. up to 128GB

- **Features**

- Front IO design
- Supports three expansion slots
- DC to DC power supply; supports 24VDC (uMin=19V/uMax=30V)
- TPM2.0
- Supports system power on delay function
- Supports Intel® RAID 0,1,5
- Support additional 400W power for add-in cards

## 1.2.2 System I/O

- **Standard I/O Interface -- Font**

- One ATX power on/off
- One 4-pin terminal block
- One ATX/AT selectable switch and reset switch
- One 2-pin connector output for remote power on/off switch
- DC to DC power supply; supports 24VDC (uMin=19V/uMax=30V) with phoenix power plug
- Six USB 3.2 Gen.2 ports (10G) + two USB3.2 Gen.1 ports (5G)
- HDD access LED and three user's LEDs
- Two G.E. LAN ports (i225-LM and i219-LM)
- One Ground Terminal
- Flexible IO
  - AX93511 4 x RS-232/422/485 module (default RS-232)
  - AX93512 2 x RS-232/422/485 w/ isolated 1.5KVDC protection and 8-in/8-out isolated 1.5KVDC DIO
  - AX93516 4 x RS232/422/485 w/ one isolated 2KVDC module
  - AX93519 2 x RS232/422/485 + 2 USB3.0 (USB2.0 signal) + 1 G.E. LAN (i211-AT)



*Note: The RS-485 auto flow control only supports below formats to communicate data:*

8 data bits + 1 stop bit

8 data bits + 1 parity bit + 1 stop bit

8 data bits + 1 parity bit + 2 stop bits

8 data bits + 2 stop bits

7 data bits + 1 parity bit (even or odd) + 2 stop bits

- One VGA supports resolution up to 1920 x 1200 @60Hz

- One HDMI 1.4b supports resolution up to 4096 x 2160 @24Hz
- One Audio (Line-out)

### 1.2.3 Others

- **Drive Capacity**

- Two HDD drive bays (default, external, 7/9.5mm SSD/HDD height)
- The third HDD drive bay (optional, internal, 7/9.5/15mm SSD/HDD height)
- One M.2 Key M 2280 socket (PCIe x4 Gen.3) for NVMe SSD



*Note: Since Gen. 2 SSD with JMicron controller has compatibility issues with Intel PCH, it is strongly recommended to use Gen. 3 SSD on .*

- **Expansion Slot**

- One on-board full-size PCI Express Mini Card slot (USB/PCIe interface) w/ one SIM slot
- One M.2 Key E 2230 socket w/ two antenna openings
- One M.2 Key B 3042/3050 socket w/ one SIM slot (w/ optional antenna bracket)
- Two PCIe x8 slots (x4 signal)
- One PCIe x16 slot

- **USB**

- One USB2.0 (internal, 180D type A connector)



*Note: The maximum power rating for expansion slots at 60 °C cannot exceed the following value:*

*The maximum power loading of +3.3V+5V+12V<400W*



*Note: The system power rating may thus be changed base on different combinations of attached devices.*

- **Power Input**

- 24VDC (uMin=19V/uMax=30V) with 4-pin phoenix power plug
- Inrush current 40A or less

- **Operation Temperature**

Proc No	WATT	core	thread	base frequency	Operating temperature (Ambient with air flow & W.T. HDD or W.T. SSD)
XeonW-1270TE	35W	8	16	2.0 GHz	-10°C -60°C
XeonW-1250TE	35W	6	12	2.4 GHz	-10°C -60°C
XeonW-1270E	80W	6	16	3.4 GHz	-10°C -50°C
i7-10700E	65W	8	16	2.9 GHz	-10°C -50°C
i7-10700TE	35W	8	16	2.0 GHz	-10°C -60°C
i5-10500E	65W	6	12	3.1 GHz	-10°C -50°C
i5-10500TE	35W	6	12	2.3 GHz	-10°C -60°C
i3-10100E	65W	4	8	3.2 GHz	-10°C -50°C
i3-10100TE	35W	4	8	2.3 GHz	-10°C -60°C
G6400TE	35W	2	4	3.2 GHz	-10°C -60°C



*Note: The IPC system may cause CPU frequency hopping when operating in an extremely high temperature environment, and thermal throttling may occur when the system remains under full workload conditions.*



*Note: The performance of the system could be adversely affected at an over spec operating temperature or with an unrecommended processor.*



*Note: If the operating temperature is above 35°C, it is recommended to use a wide temperature SSD on the device.*



*Note: If the operating temperature is above 35°C, it is recommended to use a wide temperature Wi-Fi module on the device.*

- **Storage Temperature**

-20°C ~ 80°C

- **Humidity**

10% ~ 90% (Non-condensing)

- **Dimensions**

190 mm (W) x 192 mm (H) x 360 mm (D) (w/ internal fan module)

190 mm (W) x 192 mm (H) x 372.6 mm (D) (w/ external fan module)



*Note: All specifications and images are subject to change without notice.*



## 1.3 Block Diagrams and Dimensions

The following figures show you the motherboard and system block diagrams of the

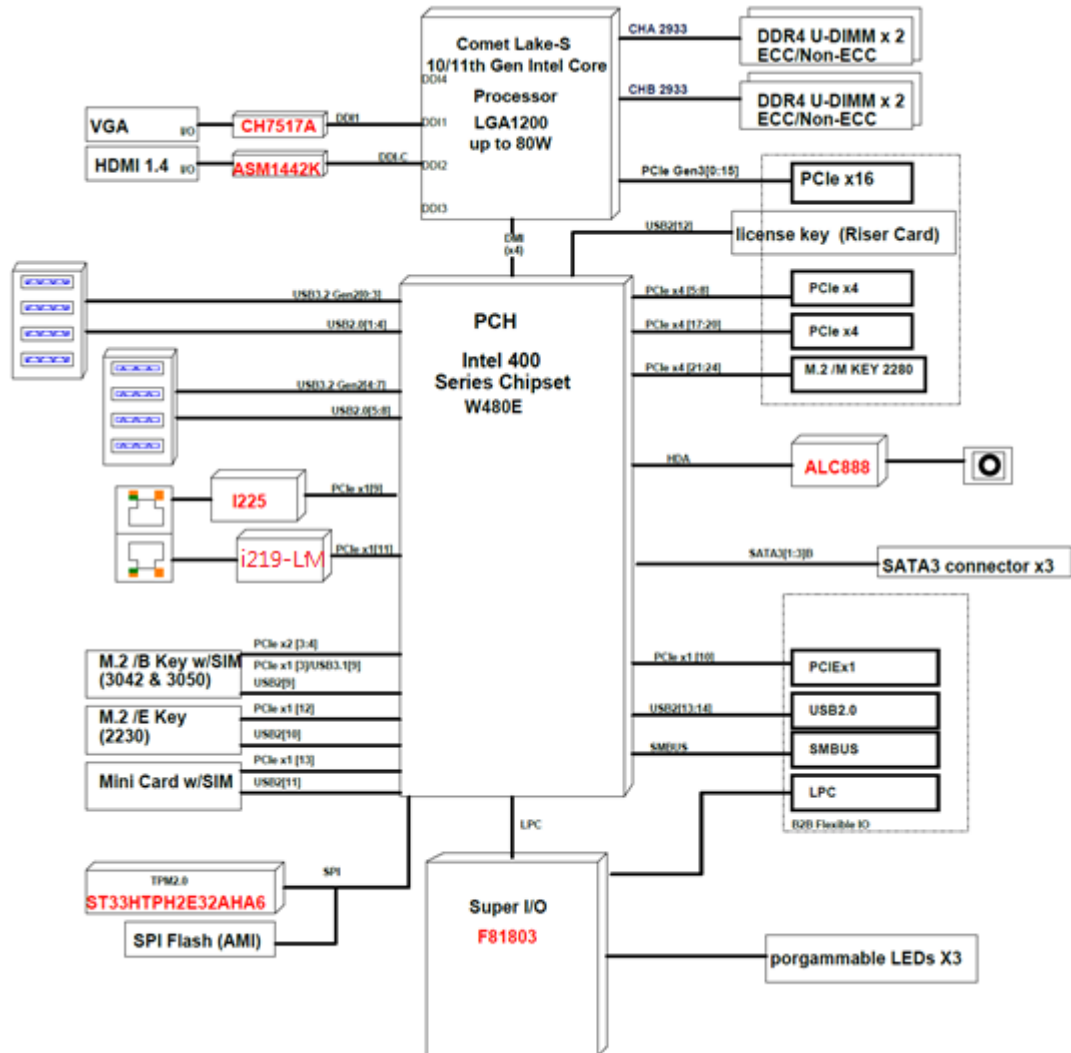

# IPC970 STD Block Diagram

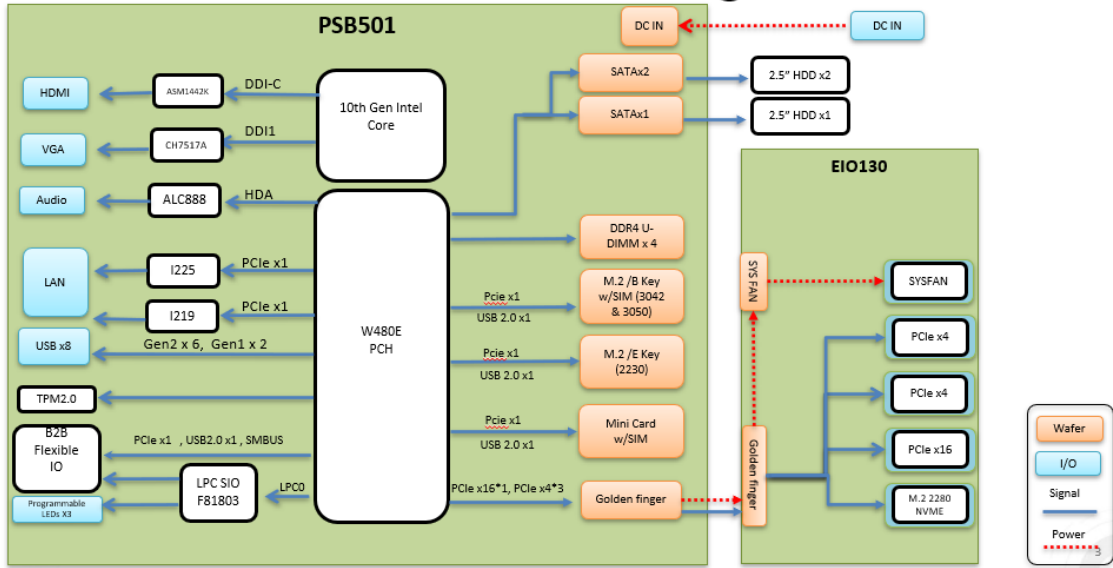

The following diagrams show you the system dimensions.

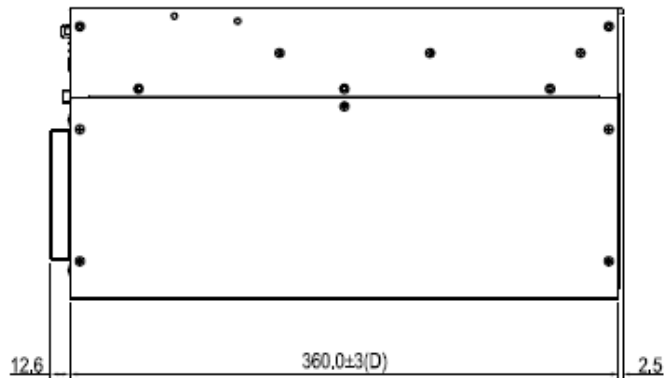
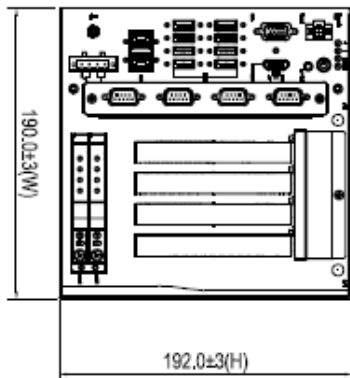
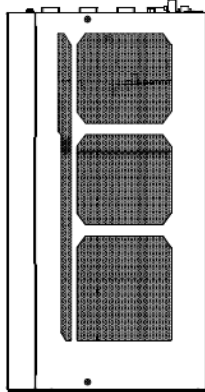
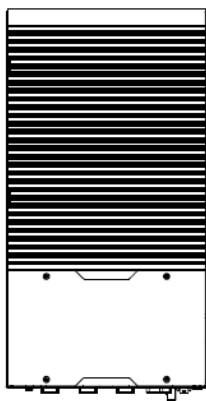

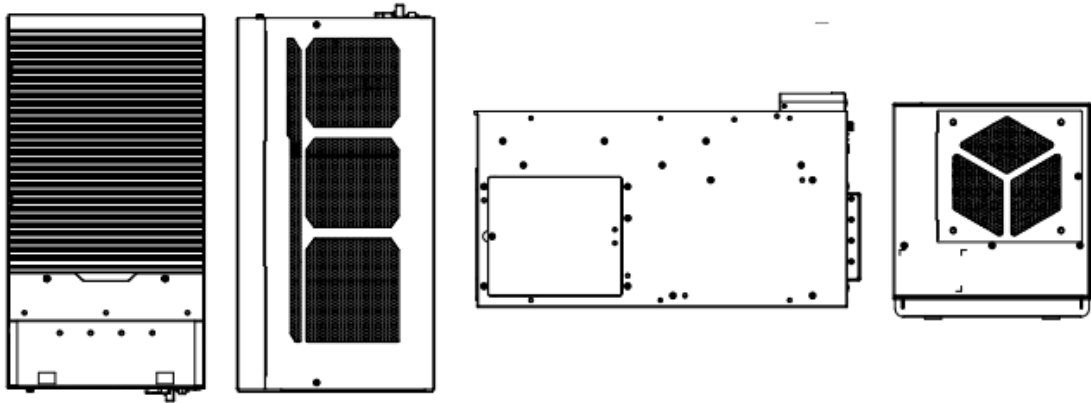
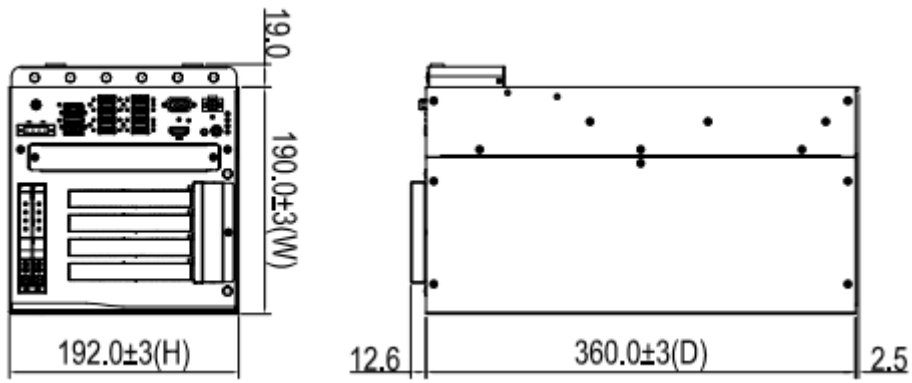
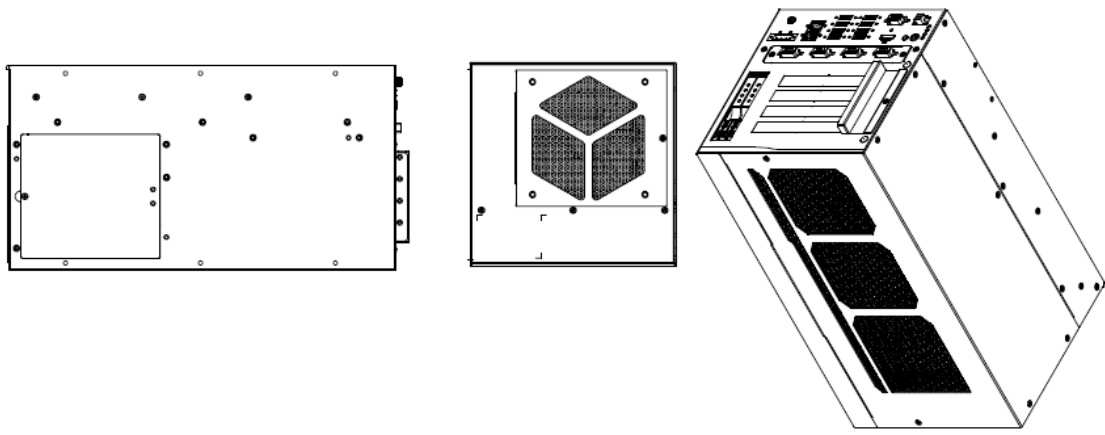

## 1.4 Outlets

The following figures show you the outlets of the .

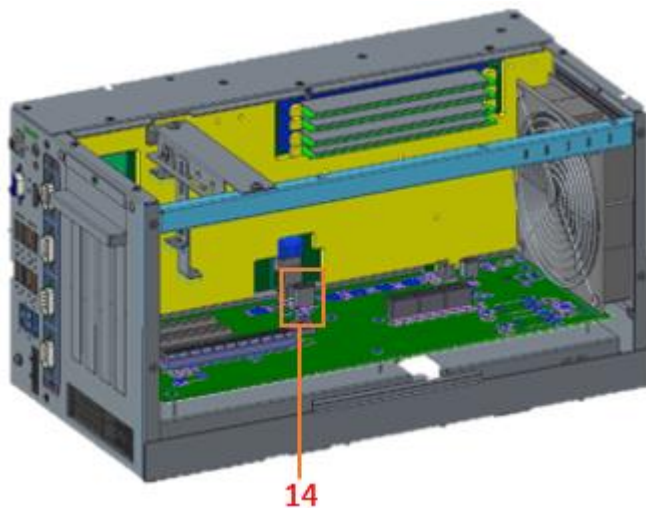
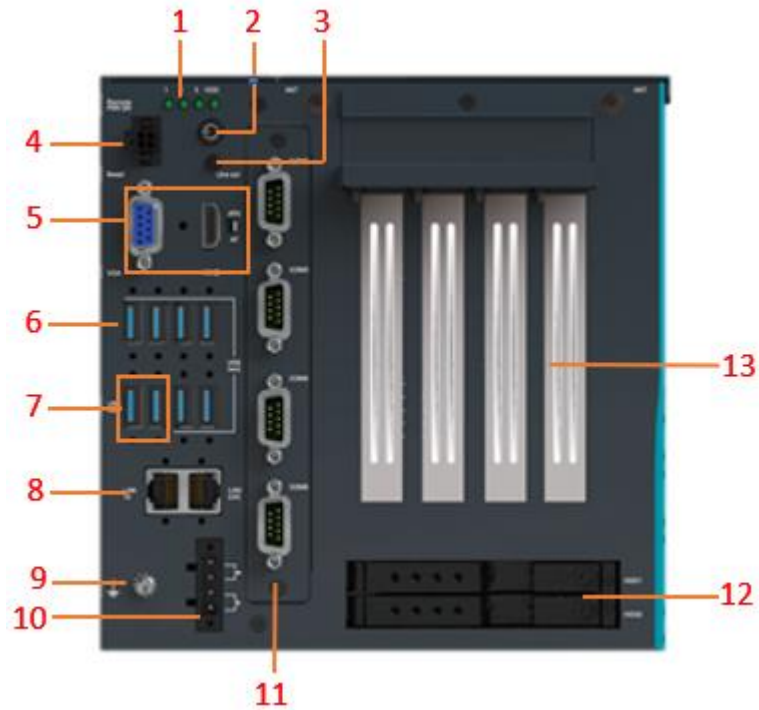

No.	Description
1	1 x SSD/HDD access LED & 3 x user's LED
2	1 x Power on/off button w/LED
3	1 x Line-out



4	1 x Remote switch & reset switch
5	1 x VGA & 1 x HDMI & 1 x AT/ATX selectable switch (default ATX)
6	6 x USB3.2 Gen.2
7	2 x USB3.2 Gen.1
8	1 x i219-LM, 1 x i225-LM
9	1 x Ground terminal
10	1 x 4-pin terminal block
11	<p>Extension system I/O module</p> <p>(1) AX93511: 4 x RS-232/422/485 module (default RS-232) (optional)</p> <p>(2) AX93512: 2 x RS-232/422/485 with isolated 1.5kVDC &amp; 8-in/8-out with isolated 1.5kVDC DIO module (optional)</p> <p>(3) AX93516: 4 x RS-232/422/485 with isolated 2kVDC module (optional)</p> <p>(4) AX93519: 1 x 10/100/1000 Mbps (Intel® i219-LM) Ethernet, 2 x RS-232/422/485, and 2 x USB 3.0(USB2.0 signal) module (optional)</p> <p>(5) Blank I/O cover (default)</p>
12	2 x 2.5" SSD/HDD drive bay
13	3 x Expansion slot
14	1 x USB2.0 type A connector







## 1.5 Packing List

The package bundled with your should contain the following items:

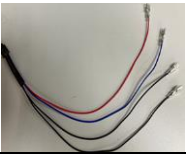
- unit x 1
- Screw pack x 1
- Foot pad x 4
- CPU grease x 1
- Terminal block x 1
- Remote and reset switch cable x 1
- Extension holder bracket kit x 1
- HDD spacer x 2
- Graphics card power cable x 2
- M.2 NVMe SSD bracket kit x1

Item	Description	Outlook	Usage	Qty
1	M2X3L screw		5G card(Key B ) & M.2 (2280)	2
2	Pillar 5.3H6.05LM23LM3 nickel plated		5G card (Key B ) & M.2 (2280)	2
3	M3*3L screw		Wi-Fi card (Key E 2230)	1
4	M2*3 screw (NYLOK)		Mini card	1
1	M3x6 screw		Wire fixing seat and isolation harness seat	4
2	Wire fixing seat		Mount	2

3	Isolation harness seat (MWS-9)		Mount	2
4	#6-32*6L screw		Holder bracket (for add-in card)	5
5	Expansion holder bracket		Add-in card	1
6	Expansion holder bracket		Add-in card	1
7	Expansion holder bracket		Add-in card	1
8	Holder bracket		Add-in card	1
9	M4*6L screw		Foot pad	4
10	Foot pad		Mount	4
11	HDD spacer		SSD/HDD (7.5mm height)	2

12	Remote switch cable L=300mm		Remote and reset switch cable	1
13	Add-on card power cable L=400mm		Add-on card	2
14	Terminal block		Power switch	1
15	NVMe SSD thermal pad		NVMe SSD	2
16	NVMe SSD bracket		NVMe SSD	1
16	M3x6L screw		NVMe SSD	2



## 1.6 Jumper Settings

Properly configure jumper settings on the PSB501 to meet your application purpose. Below you can find a summary table of all jumpers and onboard default settings.



*Note: How to setup Jumpers*

Illustrations below show that a cap on a jumper is to “close” the jumper, whereas that off a jumper is to “open” the jumper.

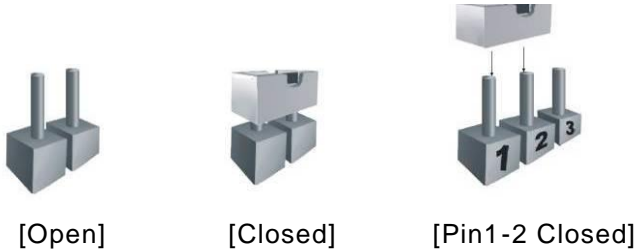

Jumper	Descriptions	Setting
JP2	Clear RTC : Normal	1-2 close
JP5&J61	DELAY Function SW	1-2 close

### 1.6.1 Restore BIOS Optimal Defaults (JP3)

Put jumper clip to pin 2-3 for a few seconds and then move it back to pin 1-2. Doing this procedure can restore BIOS optimal defaults.

Function	Setting
Normal operation (default)	1-2 close
Restore BIOS optimal defaults	2-3 close

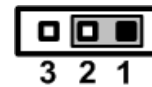

### 1.6.2 DELAY Function SW (JP5&JP6)

JP6	JP5	function
2-3 close	2-3 close	Delay power on 3s
2-3 close	1-2 close	Delay power on 6s
1-2 close	1-2 close	Disable delay function (default)



## 1.7 Connectors

Connectors connect the board with other parts of the system. Loose or improper connection might cause problems. Make sure all connectors are properly and firmly connected.

Here is a table summarizing all connectors on the board.

Connector	Label
Remote power switch connector	CN1
SIM card slot	CN3 · CN9
Audio connector	CN4
VGA connector	CN5
HDMI connector	CN6
M.2 KeyB (3042 & 3050)	CN7
USB3.0 connector	CN8 · CN10
Full-size PCI Express Mini Card slot	CN11
M.2 KeyE 2230	CN12
LAN connector	CN13
DC-in Phoenix power connector	CN14
SATA Power connector	SCN2 · SCN3 · SCN4
SATA III connector	SATA1
SATA III connector	SATA2
Power button	SW1
AT/ATX Switch	SSW1
Flexible IO – COM x4 (RS232/422/485)	AX93511
Flexible IO – Isolated COM x4 (RS232/422/485)	AX93516
Flexible IO – Isolated COM x2 (RS232/422/485) & 8 in/8 out DIO	AX93512
Flexible IO – COM x2 (RS232/422/485), USB3.0 x2 & LAN1	AX93519

### 1.7.1 Remote Power Switch Connector (CN1)

The system provides wafer pitch 2.00mm pin connector output for remote power on/off and reset switch.

Pins	Signals
1	HW_RST#
2	GND
3	FP_PSIN#
4	GND

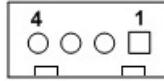

Pins	Signals	Color
1	GND	Black
2	GND	Black
3	FP_PSIN#	Red
4	HW_RST#	Blue

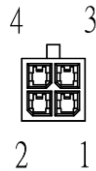

### 1.7.2 SIM Card Slots (CN3、CN9)

The system includes one SIM slot (CN3) on the top side of the system for inserting the SIM card. It is mainly used in 3G/LTE wireless network applications on SCN3.

Pin	Signal
1	PWR
2	RST
3	CLK
4	NC
5	GND
6	VPP
7	I/O
8	NC

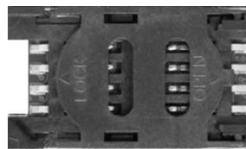
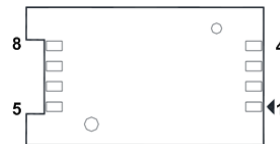

### 1.7.3 Audio Connector (CN4)

This audio jack is ideal for Audio Line-out.

Pins	Signals
1	Line Out



### 1.7.4 VGA Connector (CN5)

The CN9 is a 15-pin D-Sub connector which is commonly used for connecting a CRT monitor.

Pins	Signals	Pins	Signals
1	Red	2	Green
3	Blue	4	N.C.
5	GND	6	DETECT
7	GND	8	GND
9	+5V	10	GND
11	N.C.	12	DDC DATA
13	Horizontal Sync	14	Vertical Sync
15	DDC CLK		

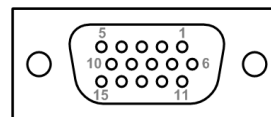

### 1.7.5 HDMI Connector (CN6)

The HDMI (High-Definition Multimedia Interface) is a compact digital interface which is capable of transmitting high-definition video and high-resolution audio over a single cable.

Pins	Signals	Pins	Signals
1	HDMI OUT_DATA2+	11	GND
2	GND	12	HDMI OUT Clock-
3	HDMI OUT_DATA2-	13	N.C.
4	HDMI OUT_DATA1+	14	N.C.
5	GND	15	HDMI OUT_SCL
6	HDMI OUT_DATA1-	16	HDMI OUT_SDA
7	HDMI OUT_DATA0+	17	GND
8	GND	18	+5V
9	HDMI OUT_DATA0-	19	HDMI_HTPLG
10	HDMI OUT Clock+		

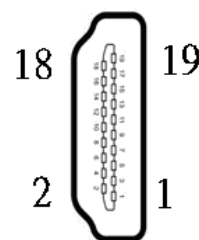

### 1.7.6 M.2 3042/3050 Key B (CN7)

Pin	Signal	Pin	Signal	Pin	Signal	Pin	Signal
1	CONFIG_3	2	+3.3V	3	GND	4	+3.3V
5	GND	6	Full Card PWR OFF	7	USB_D+	8	W_DISABLE1#
9	USB_D-	10	GPIO_9	11	GND	12	Key B
13	Key B	14	Key B	15	Key B	16	Key B
17	Key B	18	Key B	19	Key B	20	GPIO_5
21	CONFIG_0	22	GPIO_6	23	GPIO_11	24	GPIO_7
25	DPR	26	GPIO_10	27	GND	28	GPIO_8
29	USB3.1-Tx-	30	UIM-RESET	31	USB3.1-Tx+	32	UIM-CLK (O)
33	GND	34	UIM-DATA (I/O)	35	USB3.1-Rx-	36	UIM-PWR (O)
37	USB3.1-Rx+	38	NC	39	GND	40	GPIO_0
41	PERn0	42	GPIO_1	43	PERp0	44	GPIO_2
45	GND	46	GPIO_3	47	PETn0	48	GPIO_4
49	PETp0	50	PERST#	51	GND	52	CLKREQ#
53	REFCLKn	54	PEWAKE#	55	REFCLKp	56	NC
57	GND	58	NC	59	ANTCTL0	60	COEX3
61	ANTCTL1	62	COEX_RXD	63	ANTCTL2	64	COEX_TXD
65	ANTCTL3	66	SIM_DETECT	67	RESET# (I)(0/1.8V)	68	SUSCLK
69	CONFIG_1	70	+3.3V	71	GND	72	+3.3V
73	GND	74	+3.3V	75	CONFIG_2		

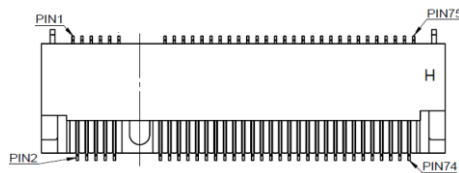

### 1.7.7 USB 3.2 Connector (CN8、CN10)

The Universal Serial Bus connectors are compliant with USB 3.2 (10Gb/s), ideal for installing USB peripherals such as scanners, cameras, USB devices, etc.

Pins	Signal USB Port 0
A1、B1、C1、D1	USB_VCC (+5V level standby power)
A2、B2、C2、D2	USB_Data-
A3、B3、C3、D3	USB_Data+
A4、B4、C4、D4	GND
A5、B5、C5、D5	SSRX-
A6、B6、C6、D6	SSRX+
A7、B7、C7、D7	GND
A8、B8、C8、D8	SSTX-
A9、B9、C9、D9	SSTX+

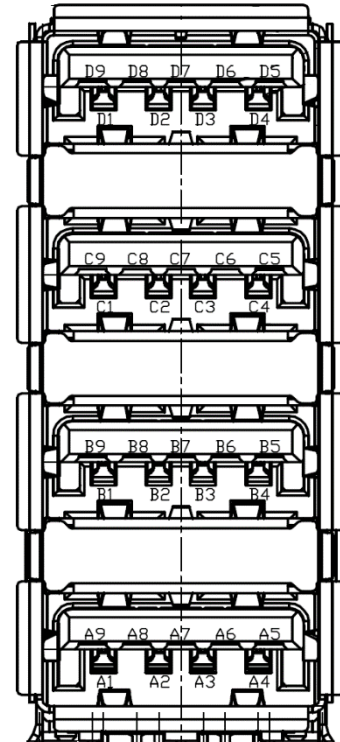

### 1.7.8 Full-Size PCI Express Mini Card Slot (CN11)

There are two PCI-Express Mini Card connectors on the bottom side applying to either PCI-Express or USB 2.0. It complies with PCI-Express Mini Card Spec. V1.2.

Pin	Signal	Pin	Signal
1	WAKE#	2	+3.3VSB
3	No use	4	GND
5	No use	6	+1.5V
7	CLKREQ#	8	No use
9	GND	10	No use
11	REFCLK-	12	No use
13	REFCLK+	14	No use
15	GND	16	No use
17	No use	18	GND
19	No use	20	W_DISABLE#
21	GND	22	PERST#
23	PE_RXN3/	24	+3.3VSB
25	PE_RXP3/	26	GND
27	GND	28	+1.5V
29	GND	30	SMB_CLK
31	PE_TXN3/	32	SMB_DATA
33	PE_TXP3/	34	GND
35	GND	36	USB_D8-
37	GND	38	USB_D8+
39	+3.3VSB	40	GND
41	+3.3VSB	42	No use
43	GND	44	No use
45	No use	46	No use
47	No use	48	+1.5V
49	No use	50	GND
51	No use	52	+3.3VSB

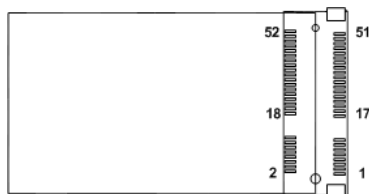

### 1.7.9 M.2 2230 Key E Wi-Fi & Bluetooth (CN12)

CN4 is used for interfacing PCI-Express and USB signals, supporting Socket 1, Key E, and type 2230.

Pin	Signal	Pin	Signal	Pin	Signal	Pin	Signal
1	GND	2	+3.3V	3	USB_D+	4	+3.3V
5	USB_D-	6	NC	7	GND	8	NC
9	NC	10	NC	11	NC	12	NC
13	NC	14	NC	15	NC	16	NC
17	NC	18	GND	19	NC	20	NC
21	NC	22	NC	23	NC	24	CONNECTOR KEY E
25	CONNECTOR KEY E	26	CONNECTOR KEY E	27	CONNECTOR KEY E	28	CONNECTOR KEY E
29	CONNECTOR KEY E	30	CONNECTOR KEY E	31	CONNECTOR KEY E	32	NC
33	GND	34	NC	35	PETp0	36	NC
37	PETn0	38	NC	39	GND	40	NC
41	PERp0	42	NC	43	PERn0	44	NC
45	GND	46	NC	47	REFCLKp0	48	NC
49	REFCLKn0	50	SUSCLK	51	GND	52	PERST0#
53	CLKREQ0#	54	W_DISABLE2#	55	PEWAKE0#	56	W_DISABLE1#
57	GND	58	I2C_DATA	59	NC	60	I2C_CLK
61	NC	62	ALERT#	63	GND	64	NC
65	NC	66	NC	67	NC	68	NC
69	GND	70	NC	71	NC	72	+3.3V
73	NC	74	+3.3V	75	GND		

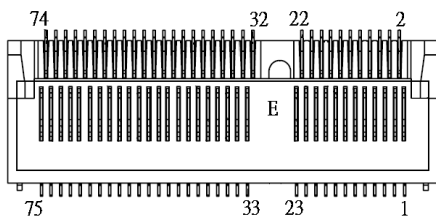



## 1.7.10 LAN Connector (CN13)

The system has two RJ-45 connectors: LAN1 and LAN2. Ethernet connection can be established by plugging one end of the Ethernet cable into this RJ-45 connector and the other end (phone jack) to a 1000/100/10-Base-T hub.

Pins	1000 Base-T	100/10 Base-T	Descriptions
L1	BI_DA+	TX+	Bidirectional or transmit Data+
L2	BI_DA-	TX-	Bidirectional or transmit Data-
L3	BI_DB+	RX+	Bidirectional or receive Data+
L4	BI_DC+	N.C.	Bidirectional or not connected
L5	BI_DC-	N.C.	Bidirectional or not connected
L6	BI_DB-	RX-	Bidirectional or receive Data-
L7	BI_DD+	N.C.	Bidirectional or not connected
L8	BI_DD-	N.C.	Bidirectional or not connected
Status LED		Status	
No Link		OFF	
Link		Yellow	
Data activity		Yellow blinking	
1G link speed LED		Status	
10Mb/s connection		OFF	
100Mb/s connection		Green	
1Gb/s connection		Orange	
2.5G link speed LED		Status	
10Mb/s or 100Mb/s connection		OFF	
1Gb/s connection		Green	
2.5Gb/s connection		Orange	

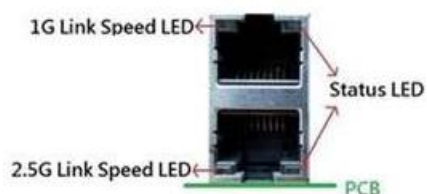
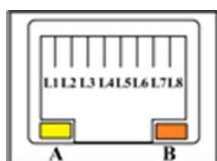

### 1.7.11 DC-in Phoenix Power Connector (CN14)

The system supports a 24VDC (uMin=19V/uMax=30V) Phoenix DC-in connector for system power input.

Pins	Signals
1	DC+
2	DC+
3	DC-
4	DC-

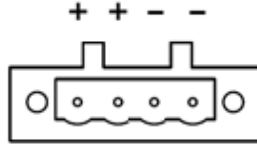

### 1.7.12 SATA Power Connector (SCN2、SCN3、SCN4)

Use SCN1、SCN2 for interfacing to SATA 2.5" HDD power supply.

Pins	Signals
1	+12V level
2	GND
3	GND
4	+5V level

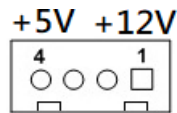

### 1.7.13 SATA Connector (SATA1~SATA2)

These Serial Advanced Technology Attachment (Serial ATA or SATA) connectors are used as high-speed SATA interfaces. They are computer bus interfaces for connecting to devices such as hard disk drives. This board has two SATA 3.0 ports with 6Gb/s performance.

Pins	Signals
1	GND
2	SATA_TX+
3	SATA_TX-
4	GND
5	SATA_RX-
6	SATA_RX+
7	GND

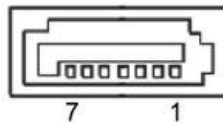

### 1.7.14 AT/ATX Power On/OFF Button (SW1)

The AT/ATX power button is on the I/O side. It allows users to control SBC87519 power on/off.

Function	Description
On	Turn on/off system
Off	Keep system status



### 1.7.15 AT/ATX Switch (SSW1)

If you set AT/ATX switch to AT mode, the system will be automatically powered on without pressing the soft power button during power input. We can use this switch to achieve auto power on demand.

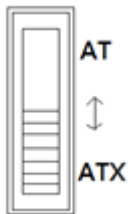

### 1.7.16 Flexible IO - COM I/O Card Connector (AX93511)

The system has four serial ports. COM1~COM4 are RS-232/422/485 ports.

\*RS-232/422/485 can be configured via BIOS settings.

#### ※COM1, COM2, COM3, COM4

Pins	RS-232	RS-422	RS-485
1	DCD, Data Carrier Detect	TX-	Data-
2	RXD, Receive Data	TX+	Data+
3	TXD, Transmit Data	RX+	No use
4	DTR, Data Terminal Ready	RX-	No use
5	GND, Ground	No use	No use
6	DSR, Data Set Ready	No use	No use
7	RTS, Request To Send	No use	No use
8	CTS, Clear To Send	No use	No use
9	RI, Ring Indicator	No use	No use

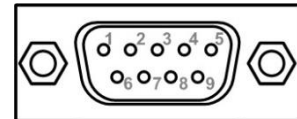

### 1.7.17 Flexible IO – Isolated COM & DIO I/O Card (AX93512)

The system has two serial ports: COM1~COM2 are RS-232/422/485 with isolated 1.5KVDC protection. DIO1~DIO2 are 8-in/8-out isolated 1.5KVDC DIO ports.

\*RS-232/422/485 can be configured via BIOS settings.

※COM1, COM2, DIO1, DIO2

CN1 (COM1) & CN2 (COM2)			
Pins	RS-232	RS-422	RS-485
1	DCD, Data Carrier Detect	TX-	Data-
2	RXD, Receive Data	TX+	Data+
3	TXD, Transmit Data	RX+	No use
4	DTR, Data Terminal Ready	RX-	No use
5	GND, Ground	No use	No use
6	DSR, Data Set Ready	No use	No use
7	RTS, Request To Send	No use	No use
8	CTS, Clear To Send	No use	No use
9	RI, Ring Indicator	No use	No use
10	GND_EARTH	No use	No use

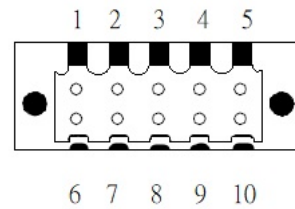

CN3 (DIO1)		CN4 (DIO2)	
Pin	Function	Pin	Function
1	Common1 PWR+	1	Common2 PWR+
2	DO10	2	DO20
3	DO11	3	DO21
4	DO12	4	DO22
5	DO13	5	DO23
6	Common 1 PWR-	6	Common 2 PWR-
7	External 1 Power	7	External 2 Power
8	DI10	8	DI20
9	DI11	9	DI21
10	DI12	10	DI22
11	DI13	11	DI23
12	Isolation 1 GND	12	Isolation 2 GND

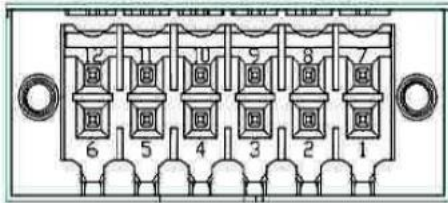

## Digital I/O Specification (per port)

- **Isolated Digital Input**

The figure shows how to connect between external input source and the system.

Each of the isolated digital input channels accepts 0~30 VDC with sink type and source type.

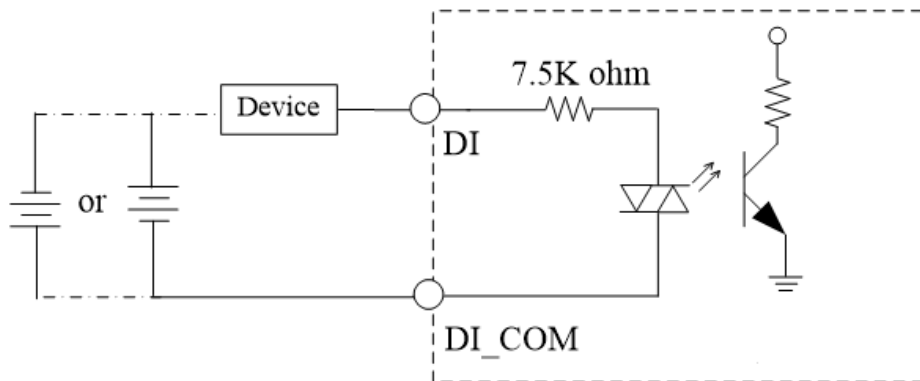

- **Isolated Digital Output**

The figure shows how to connect between an output channel and the system.

If an external 5~30 VDC voltage is applied to an isolated output channel, the current will flow from the external voltage source to the system.

Please note that the current through each DO channel should not exceed 200 mA.

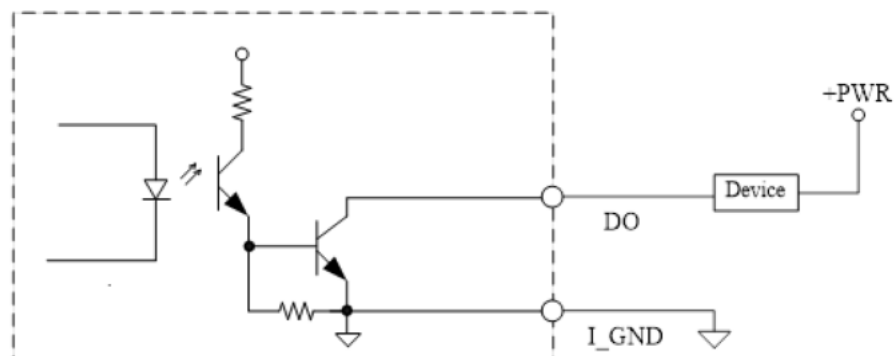

### 1.7.18 Flexible IO – Isolated COM x4 I/O Card (AX93516)

The system has four serial ports. COM1~COM4 are RS-232/422/485 isolated 2KV ports.

\*RS-232/422/485 can be configured via BIOS settings.

#### ※COM1, COM2, COM3, COM4

Pins	RS-232	RS-422	RS-485
1	DCD, Data Carrier Detect	TX-	Data-
2	RXD, Receive Data	TX+	Data+
3	TXD, Transmit Data	RX+	No use
4	DTR, Data Terminal Ready	RX-	No use
5	GND, Ground	No use	No use
6	DSR, Data Set Ready	No use	No use
7	RTS, Request To Send	No use	No use
8	CTS, Clear To Send	No use	No use
9	RI, Ring Indicator	No use	No use
10	GND_EARTH	No use	No use

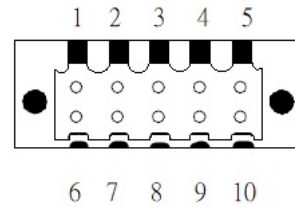



### 1.7.19 Flexible IO – USB3.0 x2 & COM x2 (RS232/422/485) & LAN1 (AX93519)

The Universal Serial Bus connectors are compliant with USB 3.0 (5Gb/s), providing ideal interfaces for installing USB peripherals such as scanners, cameras and other USB devices.

Pins	Signal USB Port 0	Pins	Signal USB Port 1
1	USB_VCC (+5V level standby power)	1	USB_VCC (+5V level standby power)
2	USB_Data2-	2	USB_Data3-
3	USB_Data2+	3	USB_Data3+
4	GND	4	GND
5	SSRX2-	5	SSRX3-
6	SSRX2+	6	SSRX3+
7	GND	7	GND
8	SSTX2-	8	SSTX3-
9	SSTX2+	9	SSTX3+

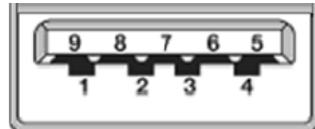

The system has two serial ports. COM1~COM2 are RS-232/422/485 ports.

\*RS-232/422/485 can be configured via BIOS settings.

※COM1,COM2

Pins	RS-232	RS-422	RS-485
1	DCD, Data Carrier Detect	TX-	Data-
2	RXD, Receive Data	TX+	Data+
3	TXD, Transmit Data	RX+	No use
4	DTR, Data Terminal Ready	RX-	No use
5	GND, Ground	No use	No use
6	DSR, Data Set Ready	No use	No use
7	RTS, Request To Send	No use	No use
8	CTS, Clear To Send	No use	No use
9	RI, Ring Indicator	No use	No use

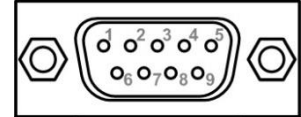

The system has two RJ-45 connectors: LAN1 Ethernet connection can be established by plugging one end of the Ethernet cable into this RJ-45 connector and the other end (phone jack) to a 1000/100/10-Base-T hub.

Pins	1000 Base-T	100/10 Base-T	Descriptions
L1	BI_DA+	TX+	Bidirectional or Transmit Data+
L2	BI_DA-	TX-	Bidirectional or Transmit Data-
L3	BI_DB+	RX+	Bidirectional or Receive Data+
L4	BI_DC+	N.C.	Bidirectional or Not Connected
L5	BI_DC-	N.C.	Bidirectional or Not Connected
L6	BI_DB-	RX-	Bidirectional or Receive Data-
L7	BI_DD+	N.C.	Bidirectional or Not Connected
L8	BI_DD-	N.C.	Bidirectional or Not Connected
A	Active Link LED (Yellow) Off: No link Blinking: Data activity detected		
B	Speed LED 1000: Orange 100: Green 10: OFF		

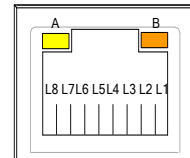

**This page is intentionally left blank.**

---

## SECTION 2

# HARDWARE INSTALLATION

The is convenient for your various hardware configurations, such as CPU (Central Processing Unit), memory module, HDD (Hard Disk Drive) and PCIe/PCI card. Chapter 2 will show you how to install these hardware parts.

### 2.1 Installing the Processor

The Intel® Xeon and Core™ i7/i5/i3 processors are available as boxed processors for the system. Intel® recommends the processors should be installed by a qualified computer professional, since this electronic device may cause serious damage to the installer, system and processor if installed improperly.



*Note: Before attempting to install a new processor, carefully review the documentation that came with your system and make sure that you will not be voiding your warranty by opening the computer or replacing your processor.*

#### Instructions:

1. Make sure that your system can accommodate the Intel® Core™ i7/i5/i3/Celeron® Processors that you want to install. Check for CPU card, BIOS, and thermal compatibility by consulting the manufacturer's documentation for the system, or by contacting the vendor if necessary. This processor should only be installed in systems supporting the Intel® Xeon and Core™ i7/i5/i3/Celeron® Processors.
2. Obtain access to your processor socket as described in the documentation for your system.
3. If the cooling solution prevents you from accessing the processor socket, you may need to remove it. Instructions on how to remove your cooling solution should be provided in the documentation that came with the system.

#### Procedure of Installation:

**Step 1** Turn off the system.

**Step 2** Disconnect the power connector.

**Step 3** Loosen 4 screws to remove the expansion cover (1), and then unscrew 6 screws to remove the heatsink cover (2) from the chassis.



**Step 4** After opening the heatsink cover, you can locate the CPU socket as marked. Align pins of the CPU with the pin holes of the socket. Beware of the CPU's orientation by aligning the arrow mark on the CPU with the arrow key on the socket. Remove the Mylar before you install the CPU into the socket.

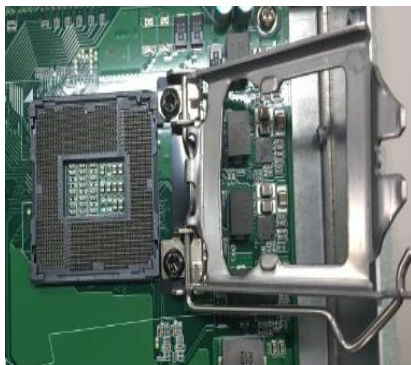

---

**Step 5** Apply thermal grease on top of the CPU



**Step 6** After installing all components, close the heatsink cover and expansion cover back to the chassis and fasten all screws.

## 2.2 Installing the Wi-Fi Module

comes with a Mini card slot and a M.2 Key E 2230 socket for users to install a wireless LAN card. Please refer to the following instructions and illustrations for the installation of the wireless LAN.

**Step 1** Turn off the system.

**Step 2** Disconnect the power connector.

**Step 3** Loosen 4 screws to remove the expansion cover(2) from the chassis.



**Step 4** Insert the wireless LAN card into the mini card slot (1) or M.2 key socket (2) and push it down firmly. Then screw the card tightly to the mainboard.



**Step 5** Remove the antenna plug from the front side, and then install the antenna on the antenna connector. The installation is complete.



*Note: Please use the supplied extended bracket when using a half-size Mini card.*

## 2.3 Installing the 5G Module

comes with a M.2 Key B 3040/3050 socket for users to install a 5G wireless module. Please refer to the following instructions and illustrations for the installation of the 5G module.

**Step 1** Turn off the system.

**Step 2** Disconnect the power connector.

**Step 3** Loosen 4 screws to remove the expansion cover(2) from the chassis.





**Step 4** Insert the 5G wireless card into the M.2 key B socket and push it down firmly and screw the card tightly to the mainboard. Then insert the SIM module into the SIM slot.



**Step 5** Remove the antenna plugs from the 5G bracket, install the antennas on the antenna connectors, and then screws the 5G bracket to the chassis. The installation is complete.



## 2.4 Installing the Memory Module

comes with four DDR4 U-DIMM sockets. Please refer to the following instructions and illustrations for the installation of the RAM module.

**Step 1** Turn off the system.

**Step 2** Disconnect the power connector.

**Step 3** Loosen 7 screws to remove the side cover from the chassis.

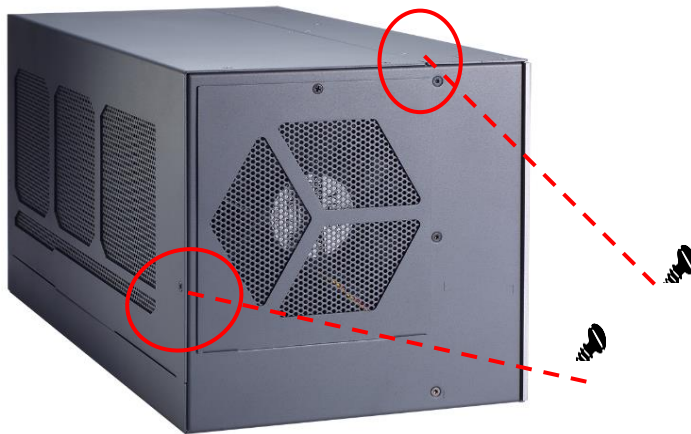

**Step 4** Install the U-DIMM into the socket and push it firmly down until it is fully seated. The socket latches are clipped onto the edges of the memory module.



The supports an optional bracket to avoid memory module bounced off from sockets. Please refer to the following instructions and illustrations for installation.

**Step 5** Take the strengthen bracket and its screws from the accessory box.



**Step 6** After installing the memory module, screws two screws to fix the brackets.

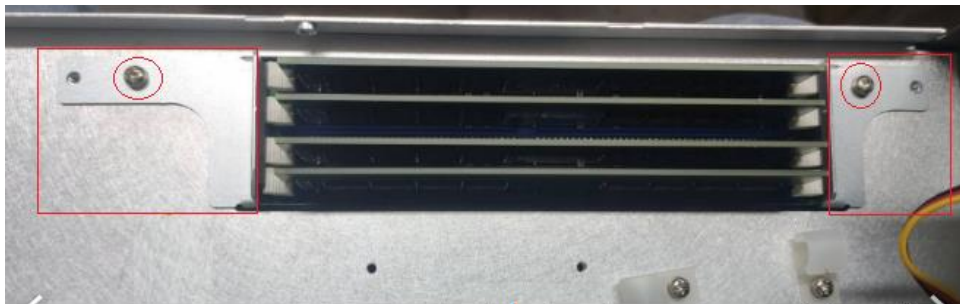

**Step 7** Close the side cover back to the chassis and fasten all screws. The installation is complete.

---

## 2.5 Installing the Hard Disk Drive and NVMe SSD

The [Mini PC](#) offers two convenient external 2.5" SSD/HDD drive bays, one NVMe SSD socket and a optional internal SSD/HDD bracket kit for installation. Please refer to the following instructions and illustrations for then installation of storage drives.

- Step 1** Turn off the system.
- Step 2** Disconnect the power connector.

### 2.5.1 Installing external SSD/HDD

- Step 1** Open the SSD/HDD tray



- Step 2** Align the connector of the SSD/HDD with the SATA slot on the main board. Then insert the SSD/HDD into the SSD/HDD bay.

- Step 3** The external SSD/HDD installation complete.



*Note: When using 7mm height HDD/SDD, please take the HDD spacer out of the accessory box and follow the steps below to stick it on HDD/SSD.*

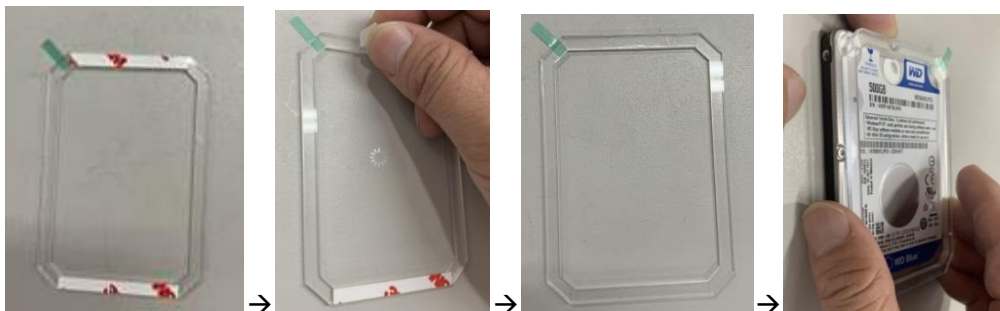



Note: The description of the 2.5" HDD Tray is as shown below.



- A1 : Triangular key lock
- A2 : Aluminum bezel
- A3 : Power & HDD access LED indication
  - Power ON : Solid Green
  - Accessing : Orange blinking

## 2.5.2 Installing SSD/HDD and NVMe SSD

**Step 1** Open the SSD/HDD & NVMe SSD cover on the bottom side of the

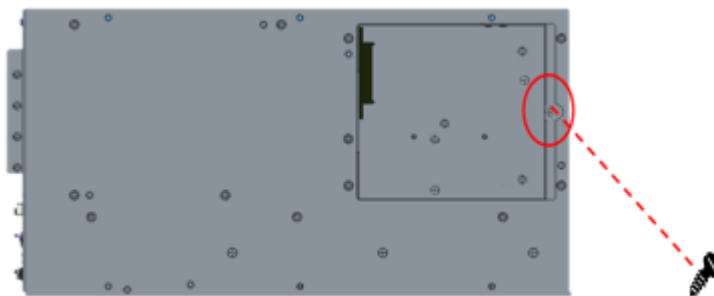

**Step 2** Take the SSD/HDD bracket and its screws from the accessory box, then screw the SSD/DD to the bracket.



**Step 3** Align the connector of the SSD/HDD with the SATA slot (#1), then insert the SSD/HDD into the bay and screw the bracket. Installation is complete.

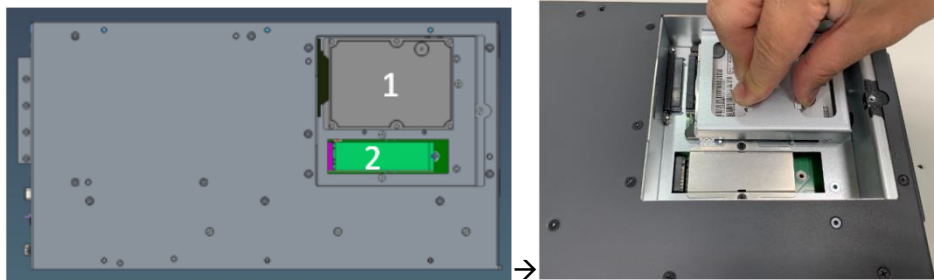

**Step 4** Take the NVMe bracket, thermal pads and its screws from the accessory box and stick a thermal pad on socket, then insert the SSD into the socket (#2) and screw it. Stick another pad on SSD.

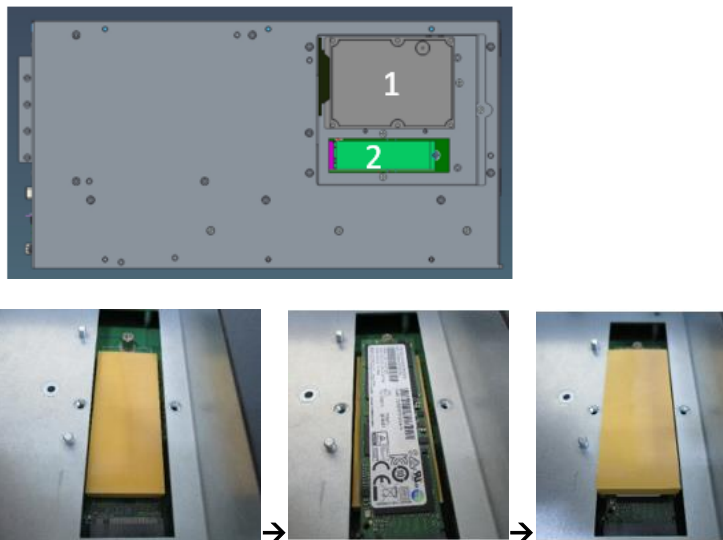

**Step 5** Screw the bracket with 2 screws. Installation is complete.

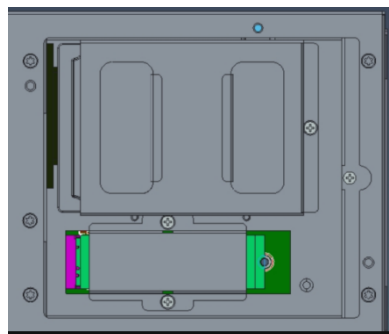

---

## 2.6 Installing the PCIe Card and External Fan Module

The provides three PCIe slots for expansion. The procedure of installing the optional fan module and the PCIe expansion card into the system is described below.

**Step 1** Turn off the system.

**Step 2** Disconnect the power connector.

**Step 3** Loosen 7 screws to remove the side cover from the chassis.



### 2.6.1 Installing PCIe add-on card

**Step 1** Locate the PCIe slots where you want to add the card and remove the slot bracket.



**Step 2** Align the PCIe card with the slot, press the card into the slot until it is firmly seated and screw it.

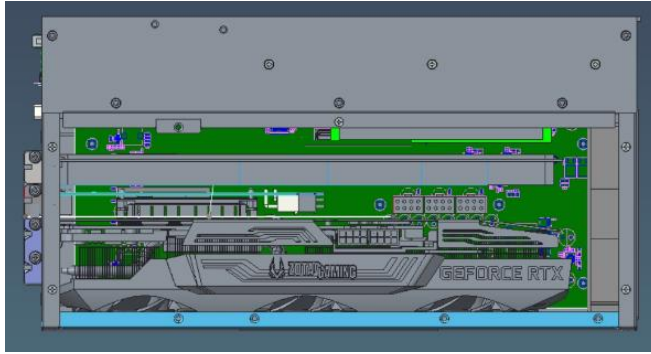

**Step 3** Take the holder bracket and its screws out of the accessory box, then fasten the holder bracket to the chassis to secure the add-on card in place.

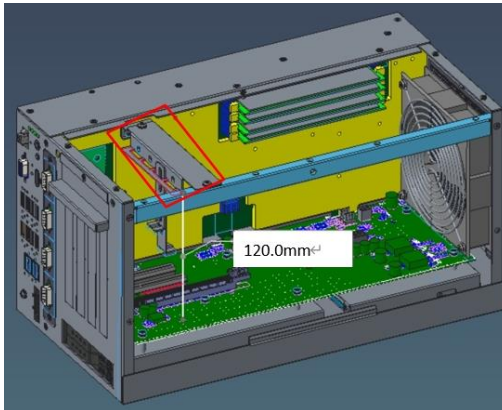

**Step 4** Close the side cover back to the chassis and fasten all screws. The installation is complete.



*Note: When installing an add-on card with height lower than 120.0 mm and higher than 52.6mm, please take the extension holder bracket out of the accessory box and follow the following steps to assemble it.*

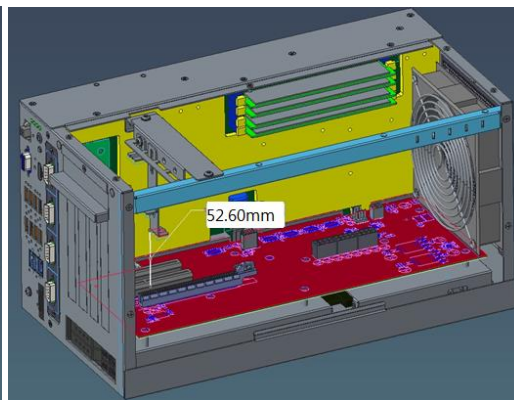
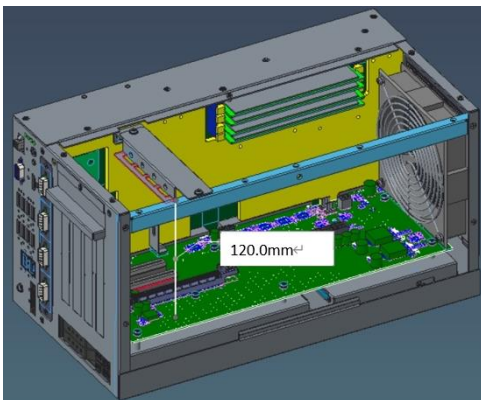



**Step 5** Connect the extension holder bracket to the holder bracket. The procedure is illustrated below.

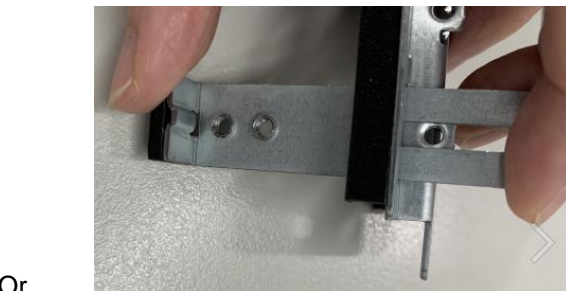
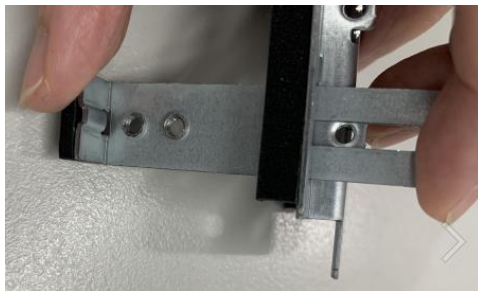

Or



**Step 6** Fasten the holder bracket in the chassis, adjust the screw position of the extension bracket to fix the add-on card, and then screw it.

 *Note: Please plug two graphics card power cables in the riser card when using a graphics card with power over 75W. (Please refer to the note of maximum power loading limitation.)*

## 2.6.2 Installing the External Fan Module

The \_\_\_\_\_ supports an internal fan module or an optional external fan module. The procedure of installing the fan module into system is illustrated below.

**Step 1** Turn off the system.

**Step 2** Disconnect the power connector.

**Step 3** Loosen 7 screws to remove the side cover from the chassis.



**Step 4** Take the fan module and its screws from the accessory box.

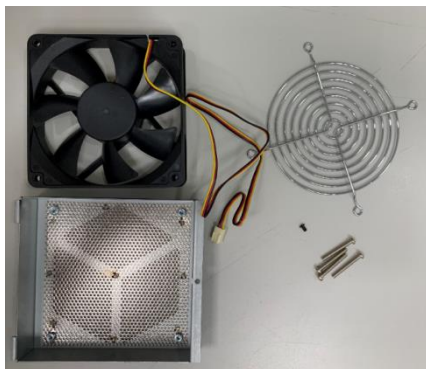

---

**Step 5** Put the fan on the fan bracket and screw the fan to the bracket.



**Step 6** Screw the fan module to the system chassis and plug the fan cable to the fan connector on the riser.

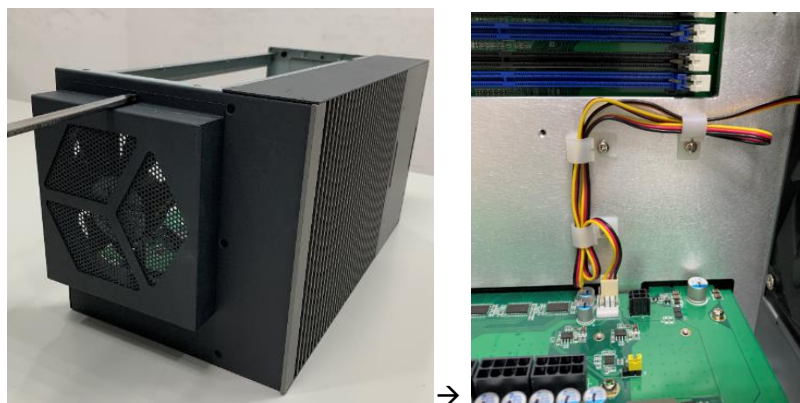

**Step 7** Close the side cover back to the chassis and fasten all screws. The installation is complete.

### 2.6.3 The limitation of an add-on card

The system supports three PCIe add-on cards. The following figures show the limitation of an add-on card in different configurations.

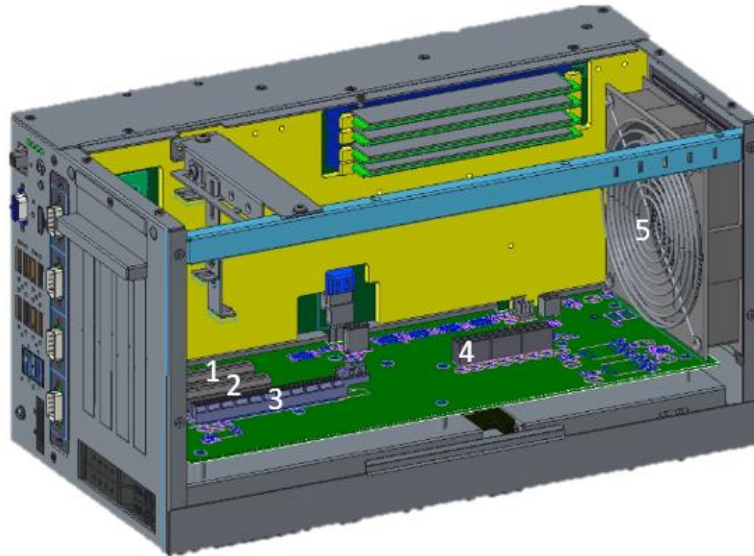

No.	Description	No.	Description
1	Slot 1: PCIe x 8 (x4 signal)	4	Power connector
2	Slot 1: PCIe x 8 (x4 signal)	5	Fan module
3	Slot 3: PCIe x 16		



*Note: Please note that below dimension is the maximum length for an add-on card with an I/O bracket.*



*Note: Considering heat dissipation potential, a space of 20mm must be left between the add-on card and the system.*

Slot	Slot 1 (PCIe x8)	Slot 2 (PCIe x8)	Slot 3 (PCIe x16)
Height	52.6-120.0 mm	52.6-120.0 mm	52.6-120.0 mm
Width	20.32 mm	20.32 mm	60.96 mm (3-slot)
<b>The following shows each slot's max. length for an add-on card in the system with different configurations.</b>			
When the internal fan is installed	336.472mm	222.832mm	336.472mm

and the add-on card's power connector on the riser card is in use.

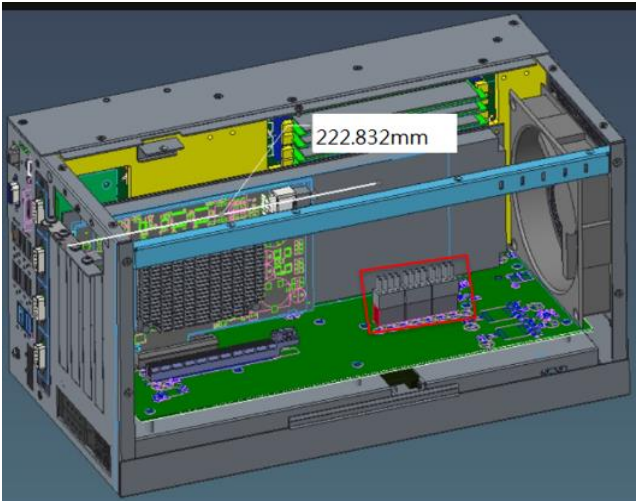

When the internal fan is installed and the add-on card's power connector on the riser card is not in use.

336.472mm	336.472mm	336.472mm
-----------	-----------	-----------

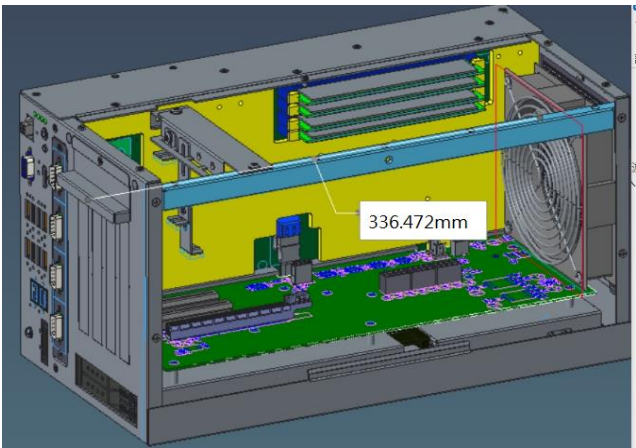

When the external fan is installed and the add-on card's power connector on the riser card is in use.

362.472mm	222.832mm	362.472mm
-----------	-----------	-----------

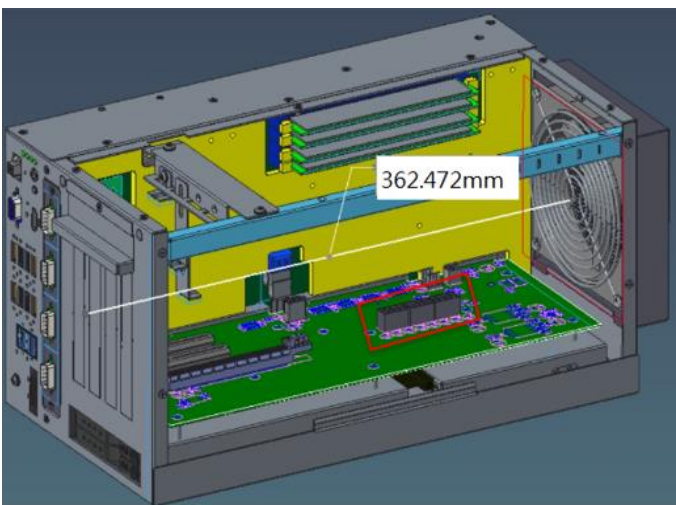

When the external fan is installed and the add-on card's power connector on the riser card is not in use.

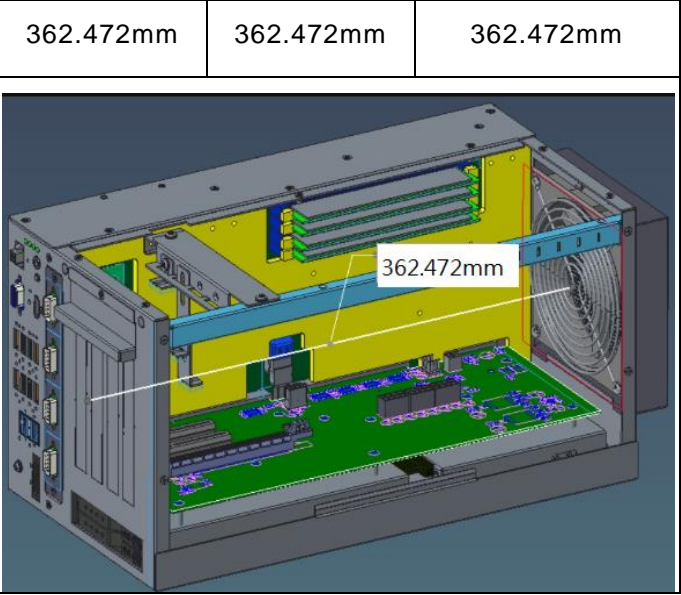

## 2.7 Installing the foot pads

**Step 1** Turn off the system.

**Step 2** Disconnect the power connector.

**Step 3** Take the foot pads from the accessory box. Screw the foot pads into system.

The installation is complete.

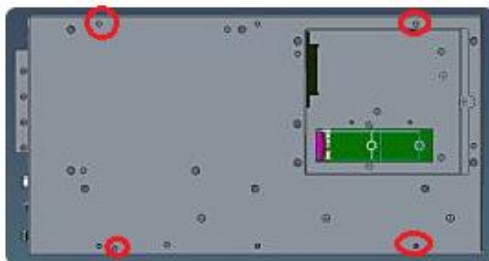

## 2.8 Wall mounting

The provides a wall mount kit for optional mounting.

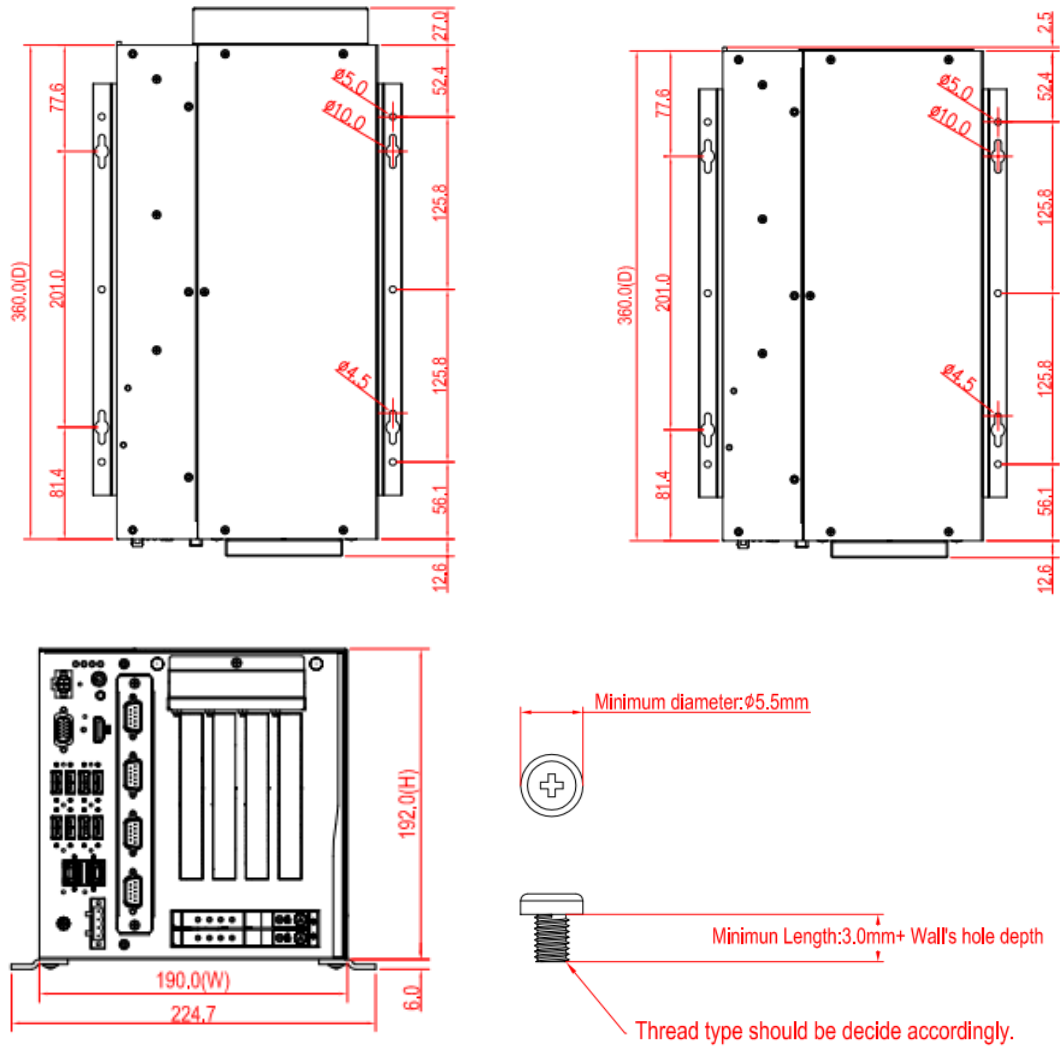

**Step 1** Turn off the system.

**Step 2** Disconnect the power connector.

**Step 3** Remove four foot pads.

---

**Step4** Assemble the wall mount bracket to the chassis, and tighten six M4x6L screws. Wall mounting installation is complete.

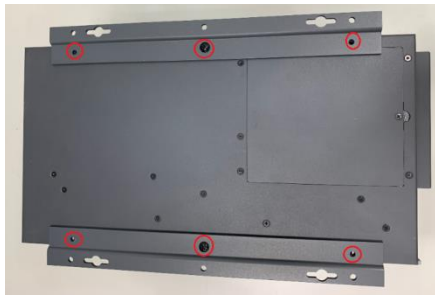



## SECTION 3

# AMI BIOS UTILITY

The AMI UEFI BIOS provides users with a built-in setup program to modify basic system configuration. All configured parameters are stored in a 16MB flash chip to save the setup information whenever the power is turned off. This chapter provides users with detailed description about how to set up basic system configuration through the AMI BIOS setup utility.

### 3.1 Starting

To enter the setup screens, follow the steps below:

1. Turn on the computer and press the <Del> key immediately.
2. After you press the <Del> key, the main BIOS setup menu displays. You can access the other setup screens from the main BIOS setup menu, such as the Advanced and Chipset menus.



**Note:** If your computer cannot boot after making and saving system changes with Setup, you can restore BIOS optimal defaults by setting JP1 (see section 1.6.2).

It is strongly recommended that you should avoid changing the chipset's defaults. Both AMI and your system manufacturer have carefully set up these defaults that provide the best performance and reliability.

## 3.2 Navigation Keys

The BIOS setup/utility uses a key-based navigation system called hot keys. Most of the BIOS setup utility hot keys can be used at any time during the setup navigation process. These keys include <F1>, <F2>, <Enter>, <ESC>, <Arrow> keys, and so on.



*Note: Some of the navigation keys may differ from one screen to another.*

Hot Keys	Description
<b>→← Left/Right</b>	The Left and Right <Arrow> keys allow you to select a setup screen.
<b>↑↓ Up/Down</b>	The Up and Down <Arrow> keys allow you to select a setup screen or sub-screen.
<b>+– Plus/Minus</b>	The Plus and Minus <Arrow> keys allow you to change the field value of a particular setup item.
<b>Tab</b>	The <Tab> key allows you to select setup fields.
<b>F1</b>	The <F1> key allows you to display the General Help screen.
<b>F2</b>	The <F2> key allows you to Load Previous Values.
<b>F3</b>	The <F3> key allows you to Load Optimized Defaults.
<b>F4</b>	The <F4> key allows you to save any changes you have made and exit Setup. Press the <F4> key to save your changes.
<b>Esc</b>	The <Esc> key allows you to discard any changes you have made and exit the Setup. Press the <Esc> key to exit the setup without saving your changes.
<b>Enter</b>	The <Enter> key allows you to display or change the setup option listed for a particular setup item. The <Enter> key can also allow you to display the setup sub- screens.

### 3.3 Main Menu

The first time you enter the setup utility, you will be in the Main setup screen. You can always return to the Main setup screen by selecting the Main tab. System Time/Date can be set up as described below. The Main BIOS setup screen is shown below.

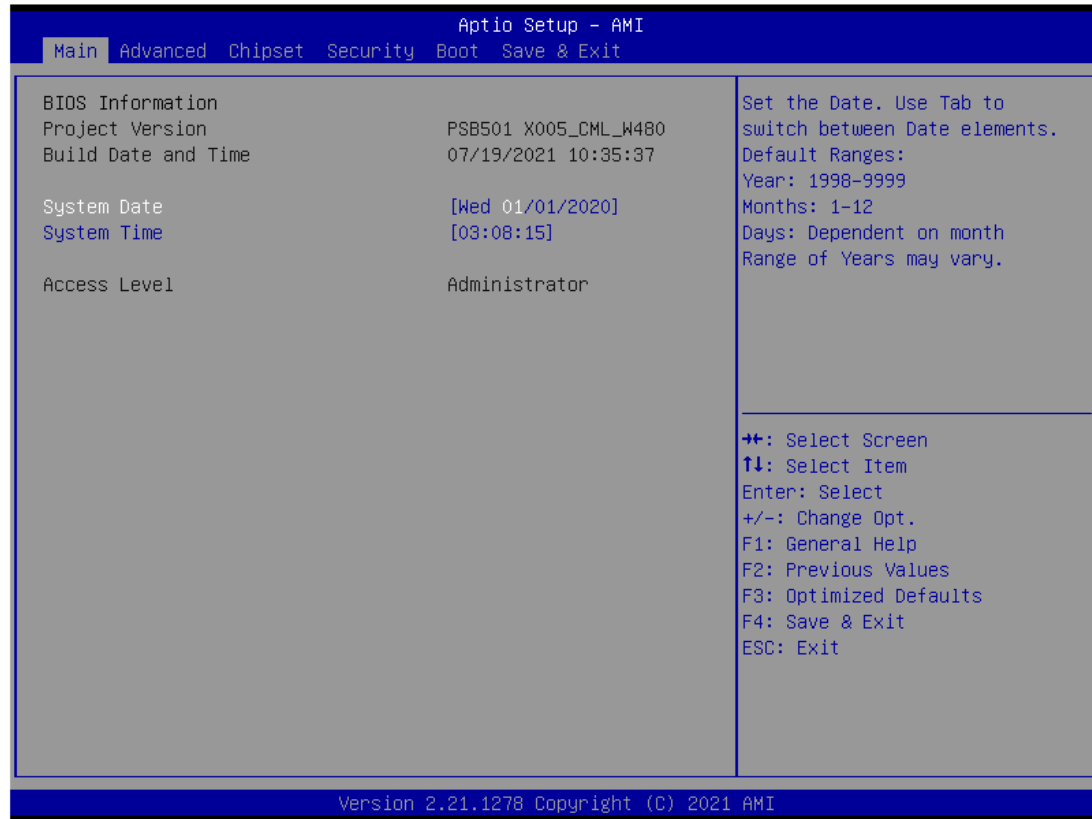

#### ➤ System Date/Time

Use this option to change the system time and date. Highlight System Time or System Date using the <Arrow> keys. Enter new values through the keyboard. Press the <Tab> key or the <Arrow> keys to move between fields. The date must be entered in MM/DD/YY format. The time is entered in HH:MM:SS format.

## 3.4 Advanced Menu

- **Launch PXE OpROM**

Use this item to enable or disable the boot ROM function of the onboard LAN chip when the system boots up.

The Advanced menu also allows users to set configuration of the CPU and other system devices. You can select any of the items in the left frame of the screen to go to the sub menus:

- ▶ ACPI Settings
- ▶ CPU Configuration
- ▶ CSM Configuration
- ▶ Hardware Monitor
- ▶ PCH-FW Configuration
- ▶ PCI Subsystem Setting
- ▶ Platform Misc Configuration
- ▶ SATA Configuration
- ▶ Trusted Computing
- ▶ USB Configuration

For items marked with “▶”, please press <Enter> for more options.

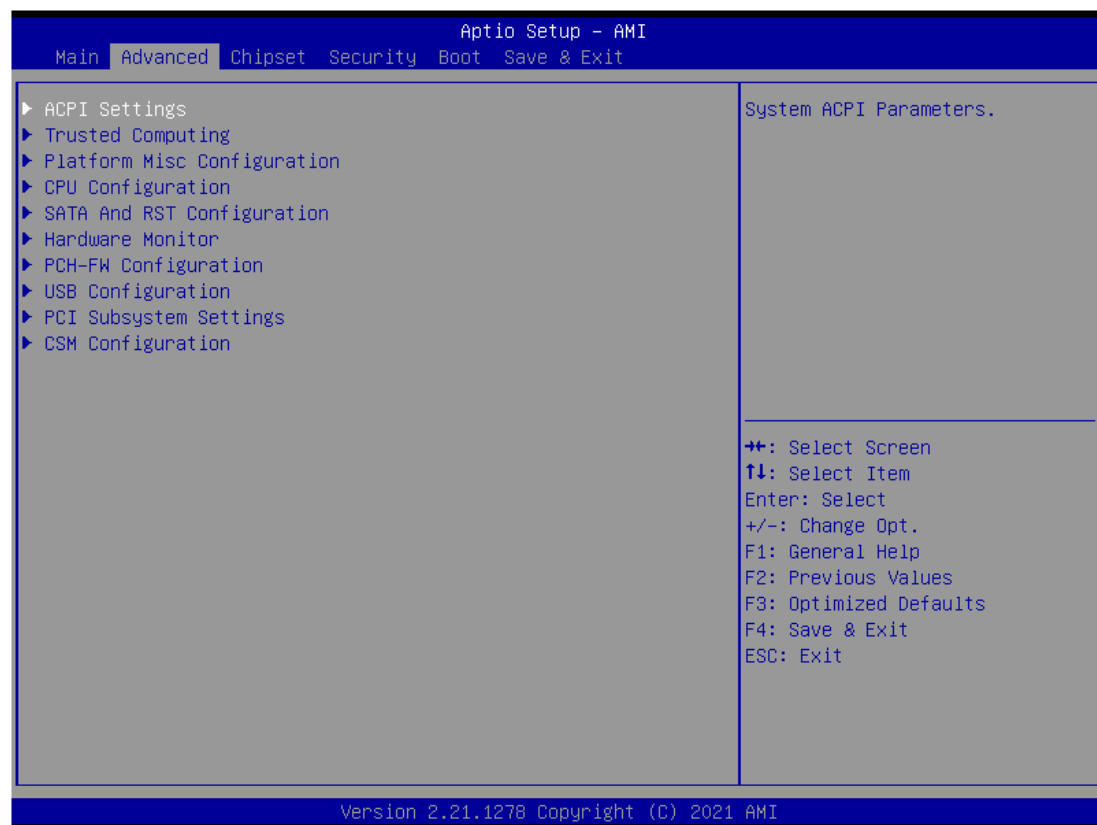

---

- **ACPI Settings**

ACPI configuration can be set in ACPI Settings. A description of the selected item appears on the right side of the screen.

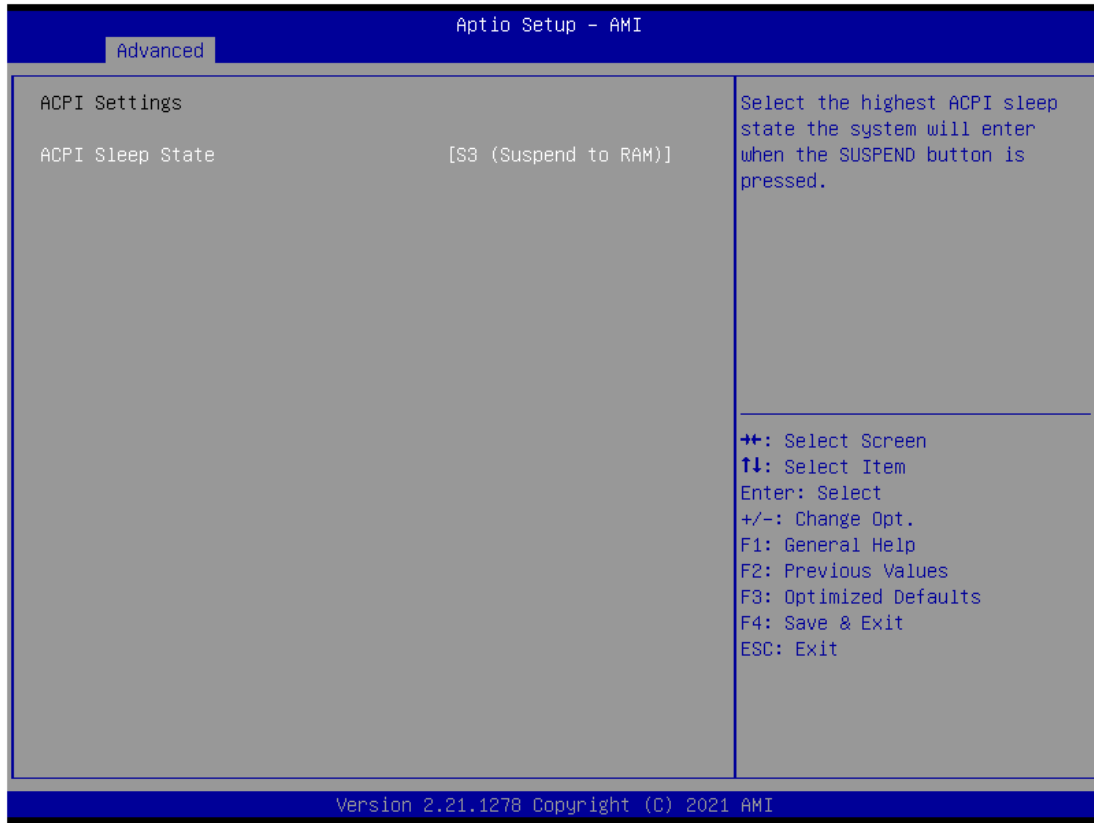

➤ **ACPI Sleep State**

Select the highest ACPI sleep state the system will enter when the suspend button is pressed. Configuration options are Suspend S3 only (Suspend to RAM).

Advanced

Ethercat Configuration		Enabled for Windows XP and Linux (OS optimized for Hyper-Threading Technology) and Disabled for other OS (OS not optimized for Hyper-Threading Technology).
Hyper-Threading	[Enabled]	
Intel(R) SpeedStep(tm)	[Disabled]	
Turbo Mode	[Disabled]	
C states	[Disabled]	
Native ASPM	[Auto]	
ACPI Sleep State	[S3 (Suspend to RAM)]	
		++: Select Screen ↑↓: Select Item Enter: Select +/-: Change Opt. F1: General Help F2: Previous Values F3: Optimized Defaults F4: Save & Exit ESC: Exit

- **CPU Configuration**

This screen shows the CPU Configuration, where you can change the value of the selected option.

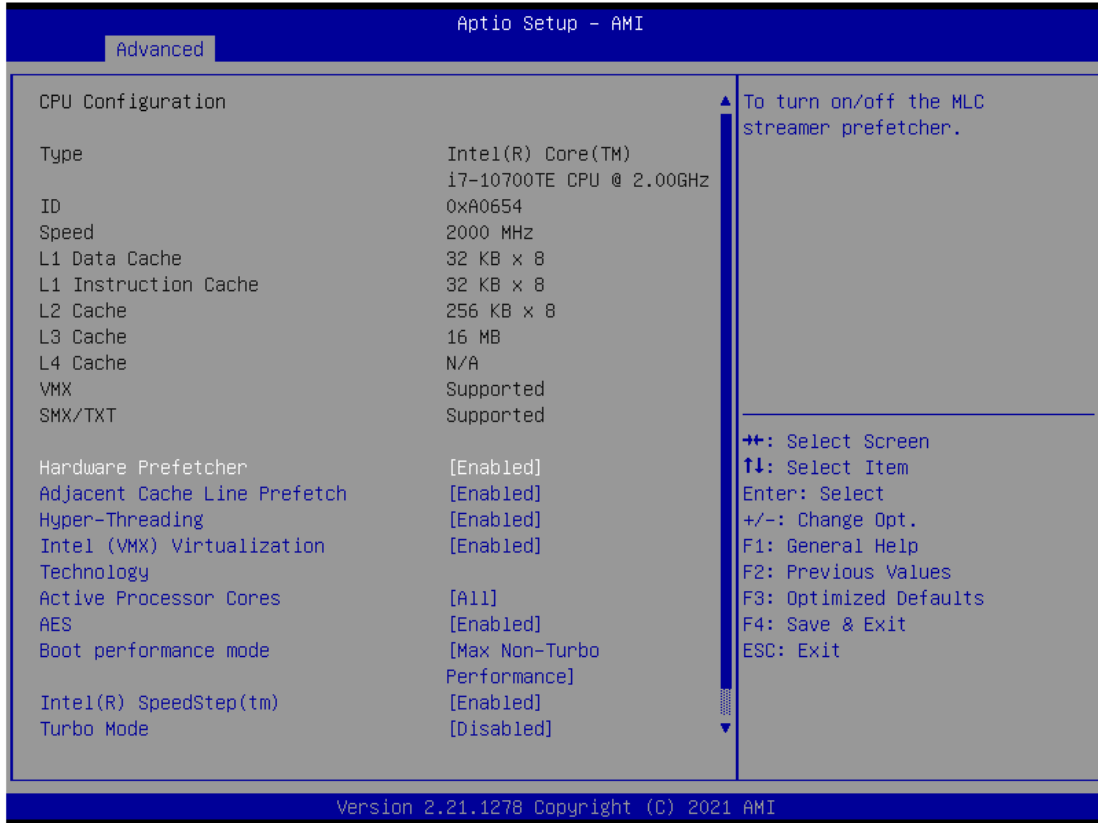

- **Intel Virtualization Technology**

This item allows a hardware platform to run multiple operating systems separately and simultaneously, enabling one system to virtually function as several systems.



*Note: Select "Disable" mode in the following 5 items to support Ethercat in CPU configuration and ACPI Settings.*

- Hyper-Threading
- Intel® SpeedStep™
- Turbo Mode
- C States
- ACPI Sleep State

- **CSM Configuration**

Aptio Setup - AMI		
Advanced		
Compatibility Support Module Configuration		Enable/Disable CSM Support.
CSM Support	[Enabled]	
CSM16 Module Version	07.84	
GateA20 Active	[Upon Request]	
INT19 Trap Response	[Immediate]	
Boot option filter	[UEFI only]	
Option ROM execution		
Storage	[UEFI]	++: Select Screen ↑↓: Select Item Enter: Select +/-: Change Opt. F1: General Help F2: Previous Values F3: Optimized Defaults F4: Save & Exit ESC: Exit
Video	[UEFI]	
Other PCI devices	[Legacy]	
Version 2.21.1278 Copyright (C) 2021 AMI		



- **Hardware Monitor**

This screen monitors hardware health.

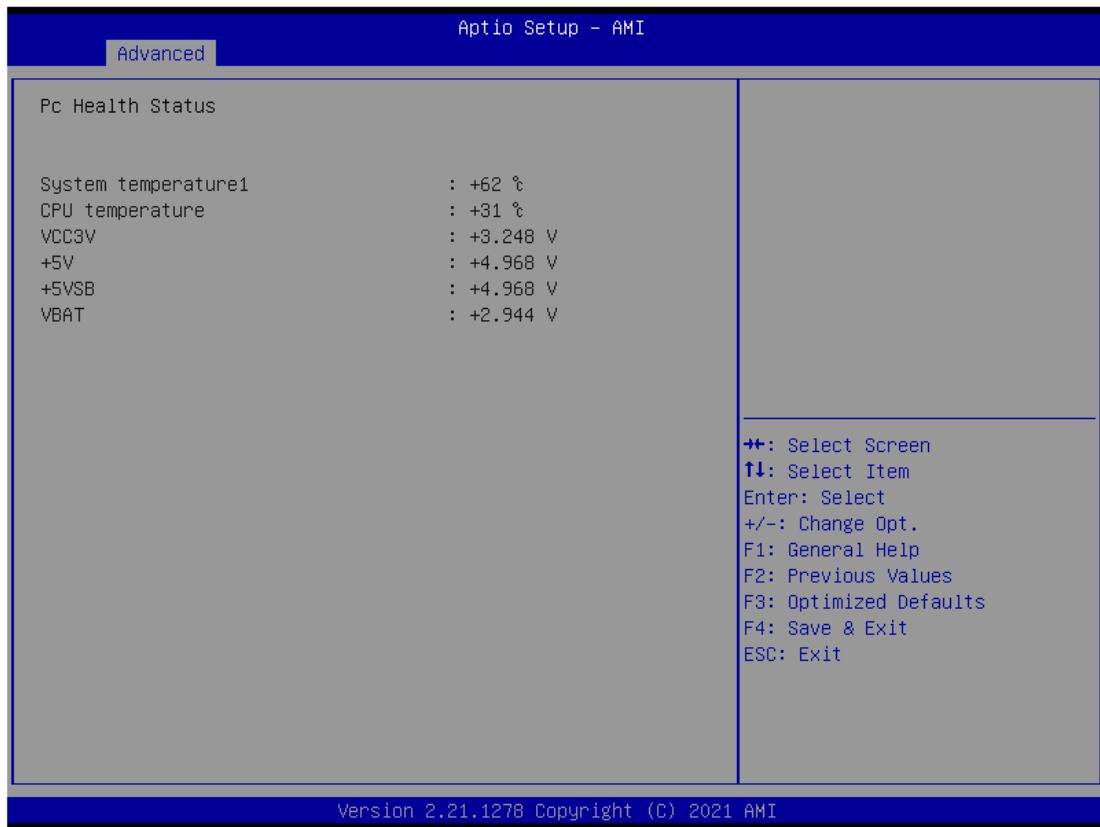

- **PCH-FW Configuration**

Display ME firmware information

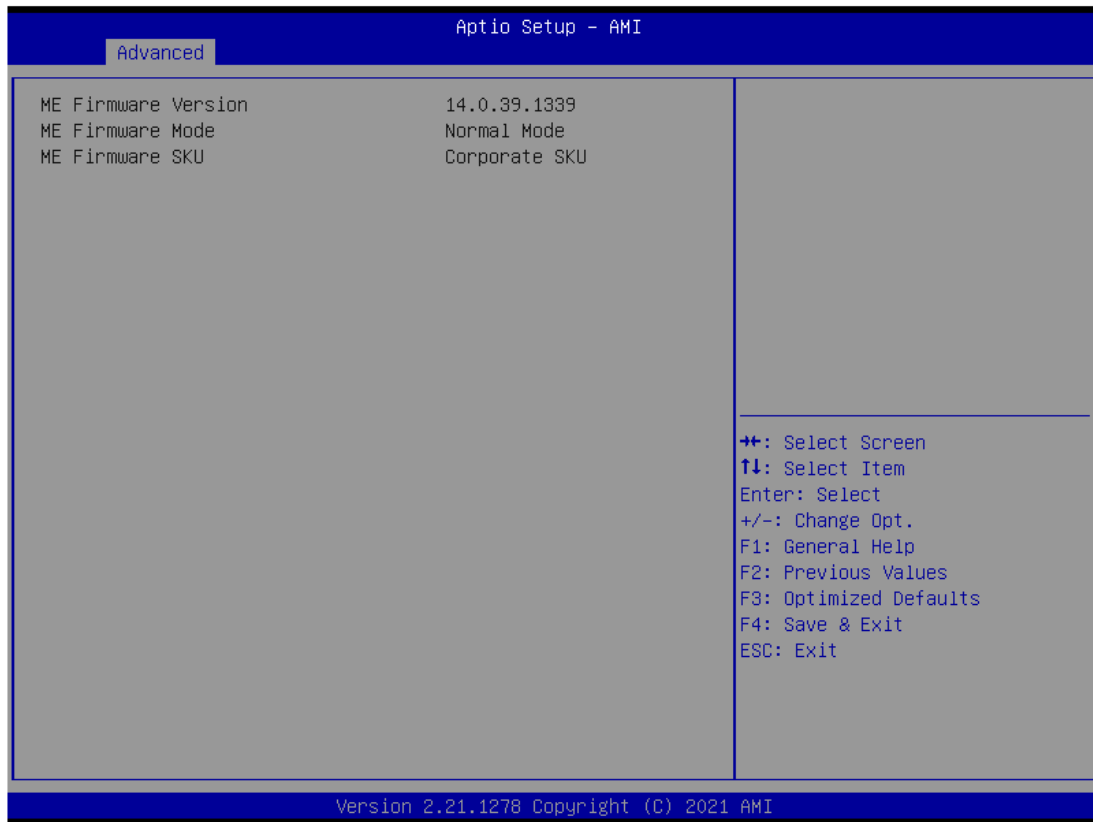

- **PCI Subsystem Settings**

This screen allows you to set PCI Subsystem mode.

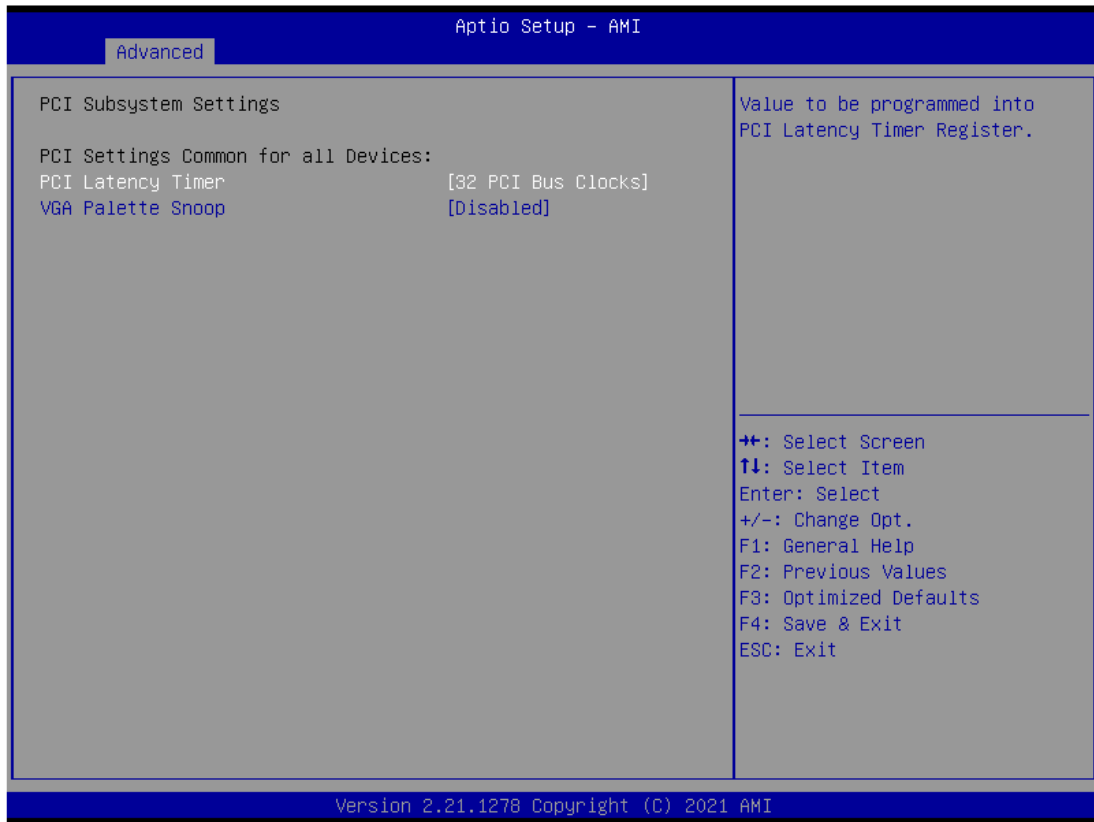

- PCI Latency Timer Set the value to be programmed into PCI Latency Timer Register. VGA Palette Snoop Enables or Disables VGA Palette Registers Snooping.

- **Platform Misc Configuration**

This screen allows you to set Platform Misc Configuration

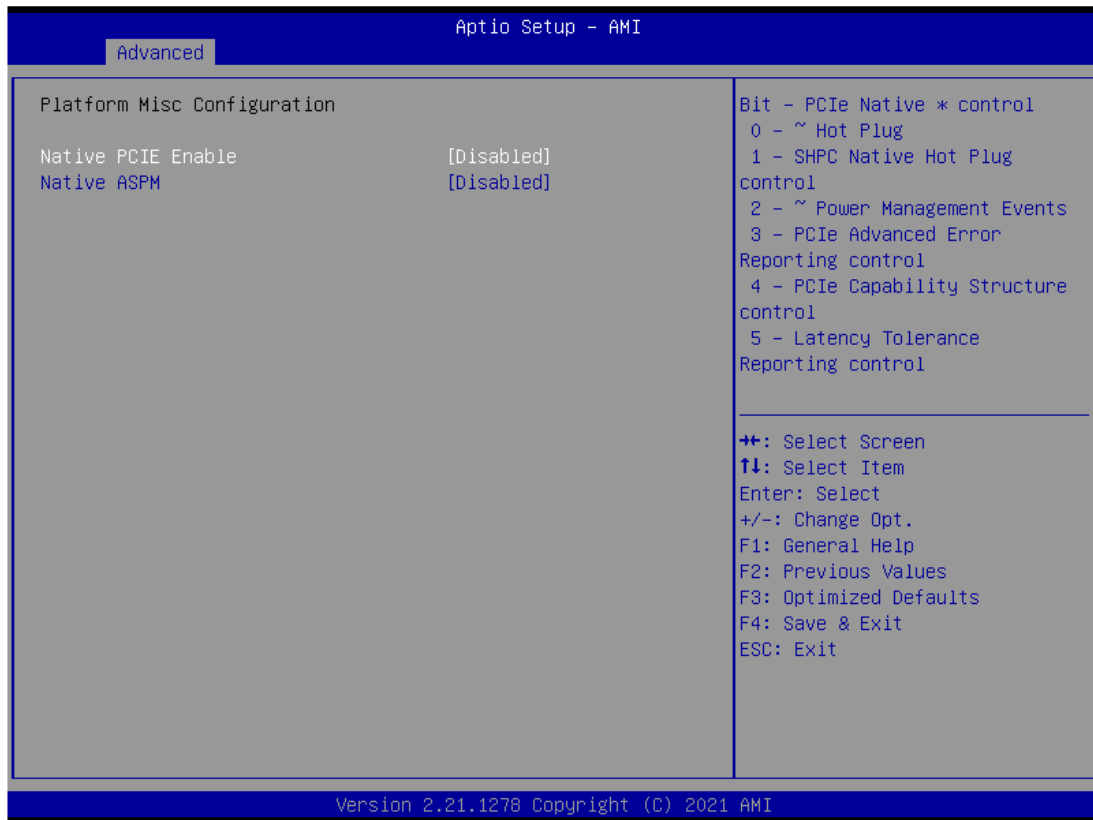

- **Native PCIE Enable**

Bit - PCIe Native \* control  
 0 - ~ Hot Plug  
 1 - SHPC Native Hot Plug control  
 2 - ~ Power Management Events Reporting control  
 3 - PCIe Advanced Error Reporting control  
 4 - PCIe Capability Structure control  
 5 - Latency Tolerance Reporting control.

- **Native ASPM**

Enabled - OS Controlled ASPM, Disabled - BIOS Controlled ASPM

- **SATA and RST Configuration**

You can read the currently installed hardware configurations from the SATA ports in the SATA Configuration menu. During system boot up, BIOS will detect the present SATA devices automatically.

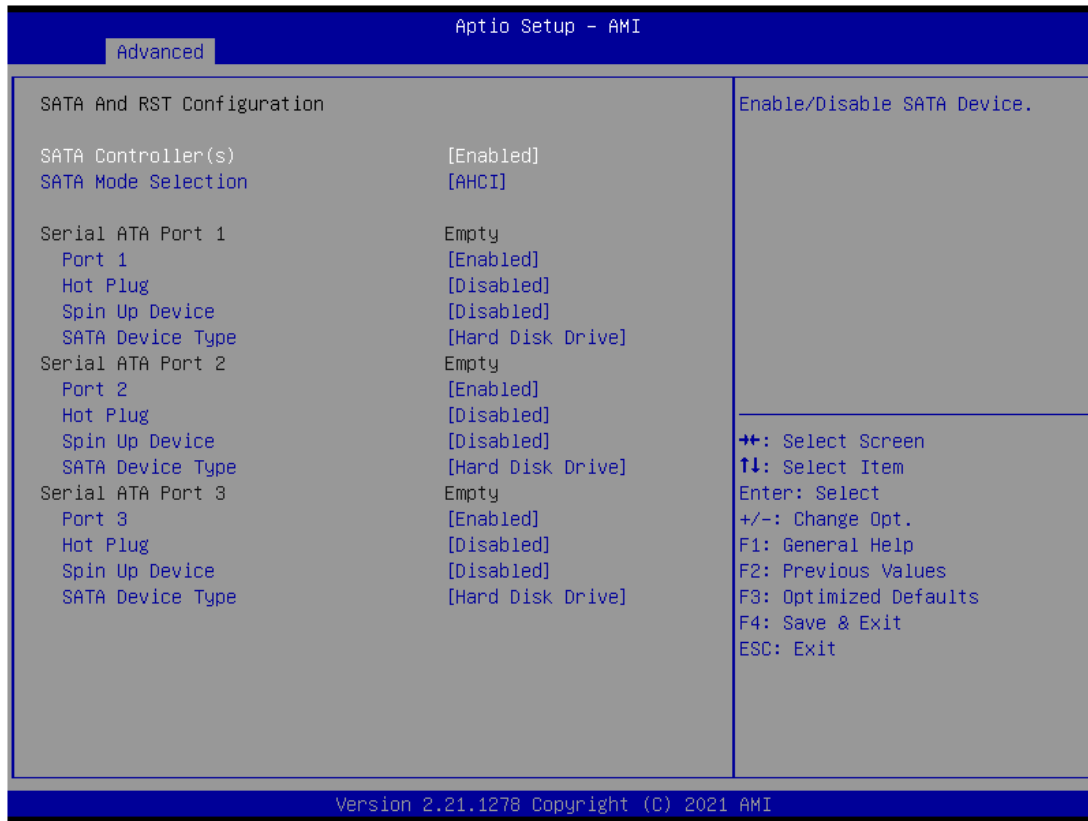

- **SATA Controller(s)**

Enable or disable the SATA Controller feature. The default is Enabled.

- **SATA Mode Selection**

Determine how SATA controller(s) operate. Operation mode options are RAID and AHCI (Advanced Host Controller Interface). The default is the AHCI mode.

- **SATA Controller**

Speed Indicates the maximum speed the SATA controller can support.

- **Hot Plug**

Designates this port as Hot Pluggable.

- **Spin Up Device**

If enabled for any of the ports, Staggered Spin Up will be performed and only the drives that have this option enabled will spin up at boot. Otherwise all drives spin up at boot.

➤ **SATA Device Type**

Identify the SATA port is connected to a solid-state drive (SSD) or hard disk drive (HDD).

● **Trusted Computing**

Select the Security Device Support to enable or disable the TPM function.

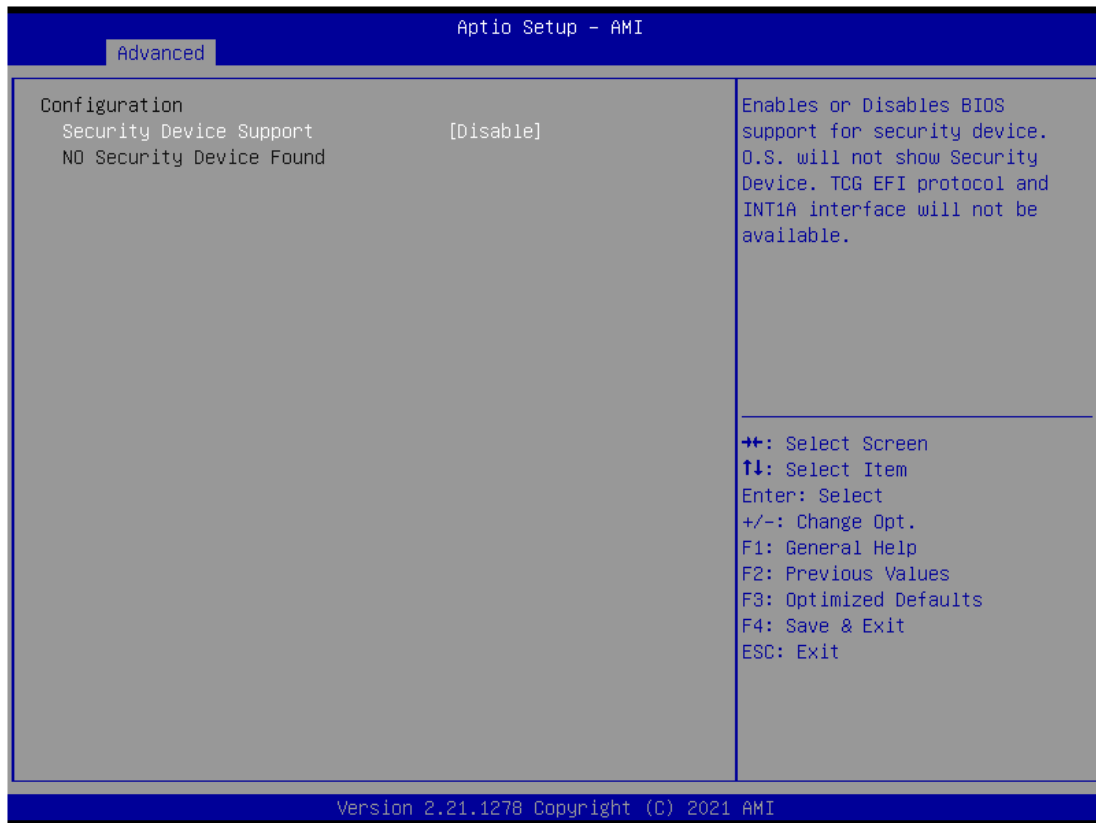

- **USB Configuration**

USB configuration can be configured here by selecting and changing each item. A description of the selected item appears on the right side of the screen.

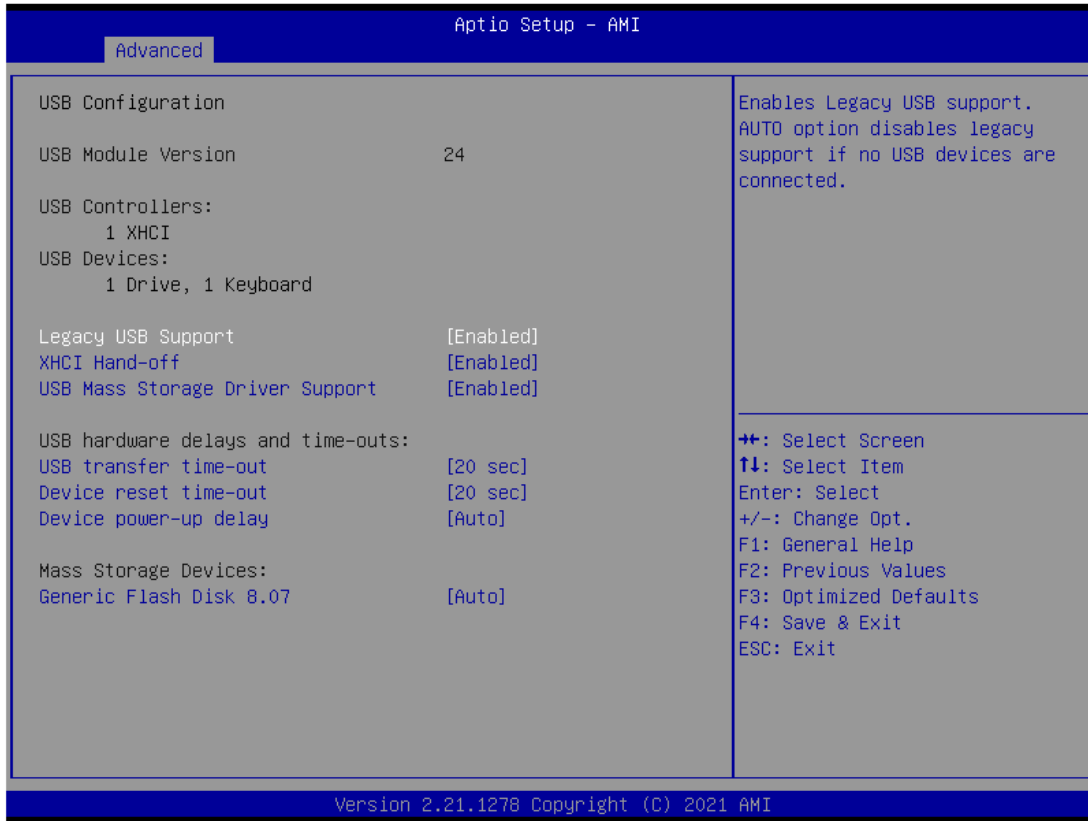

- **USB Devices**

Displays all detected USB devices.

- **Legacy USB Support**

Enables Legacy USB support. AUTO option disables legacy support if no USB devices are connected.

- **XHCI Hand-off**

This is a workaround for OSES without XHCI hand-off support. The XHCI ownership change should be claimed by XHCI driver.

- **USB Mass Storage Driver Support**

Enable/Disable USB Mass Storage Driver Support.

- **USB transfer time-out**

The time-out value for Control, Bulk and Interrupt transfers.

➤ **Device reset time-out**

USB mass storage device Start Unit command time-out.

➤ **Device power-up delay**

Maximum time the device will take before it properly reports itself to the Host Controller. 'Auto' uses default value: for a Root port it is 100 ms, for a Hub port the delay is taken from Hub descriptor.

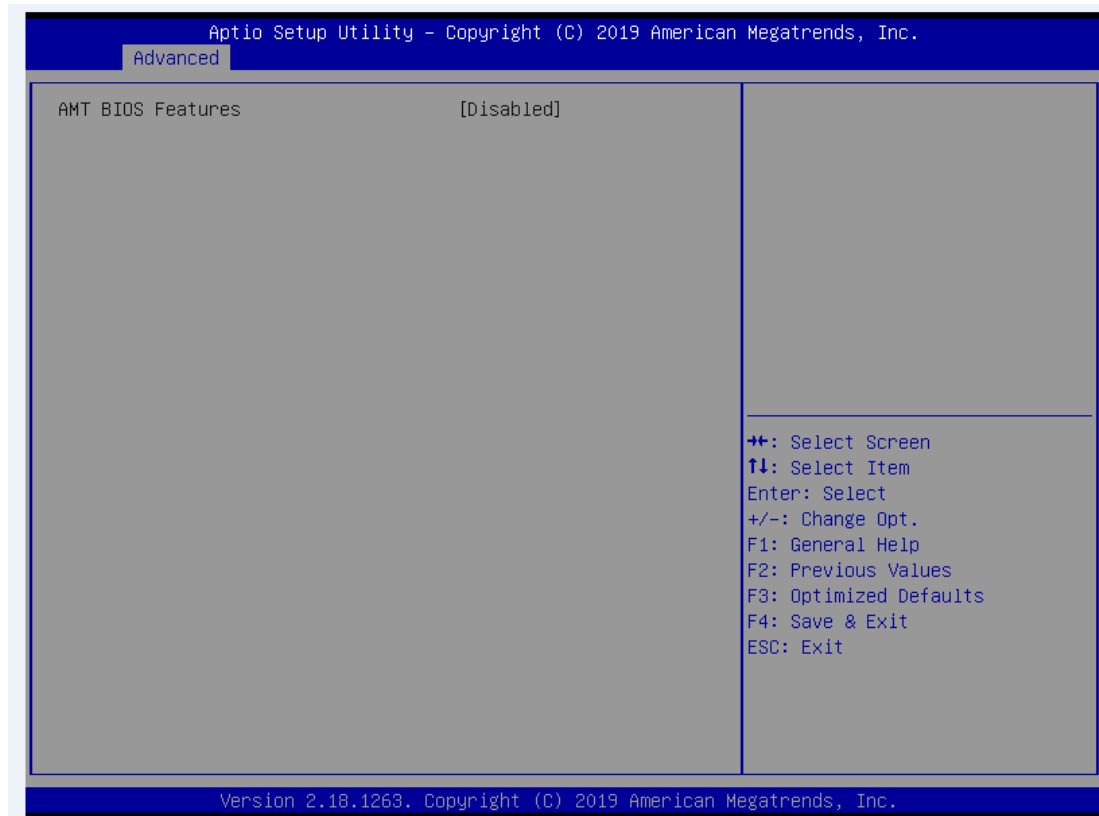



## 3.5 Chipset Menu

The Chipset menu allows users to change the advanced chipset settings. You can select any of the items in the left frame of the screen to go to the sub menus:

- ▶ **System Agent (SA) Configuration**

This screen shows System Agent information and provides functions for specifying related parameters. For items marked with “▶”, please press <Enter> for more options.

You can select any of the items in the left frame of the screen to go to the sub menus:

- ▶ System Agent (SA) Configuration
- ▶ PCH-IO Configuration



► System Agent (SA) Configuration

This screen allows users to configure System Agent (SA) parameters. For items marked with “►”, please press for more options.



- **Graphics Configuration**

Open the sub menu for parameters related to graphics configuration.

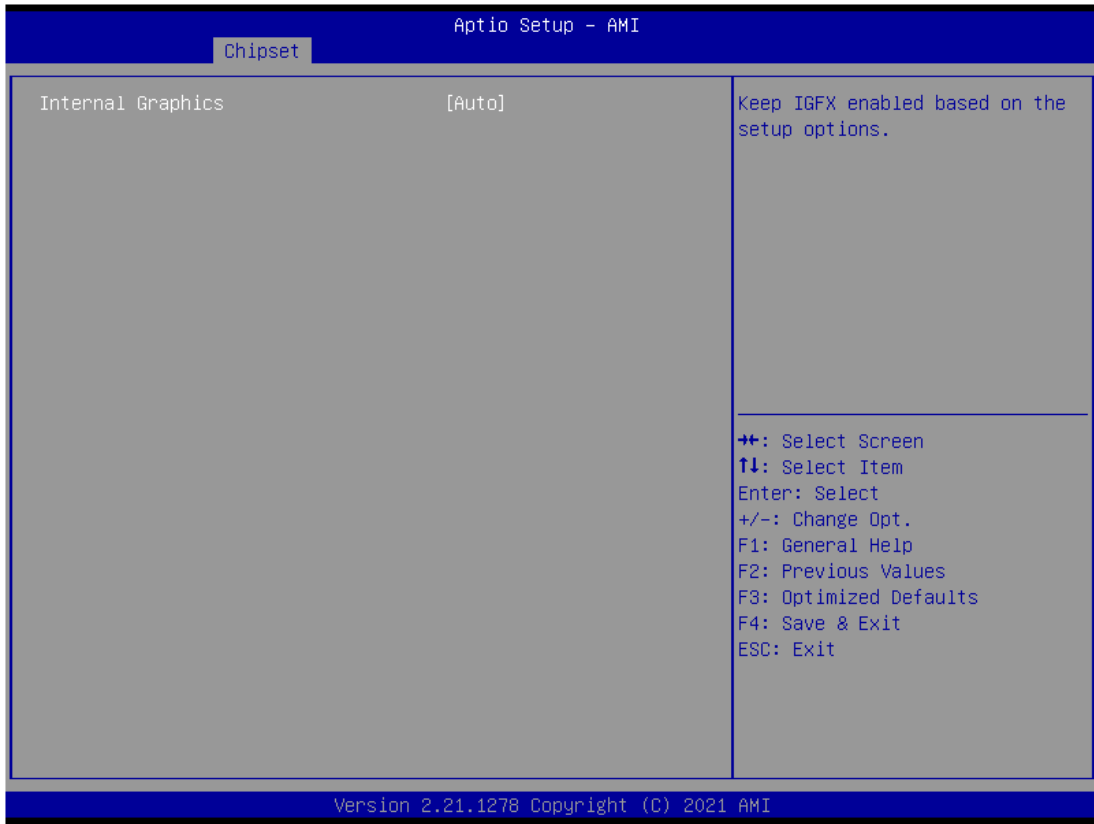

- **Memory Configuration**

Open the sub menu for information related to system memory.

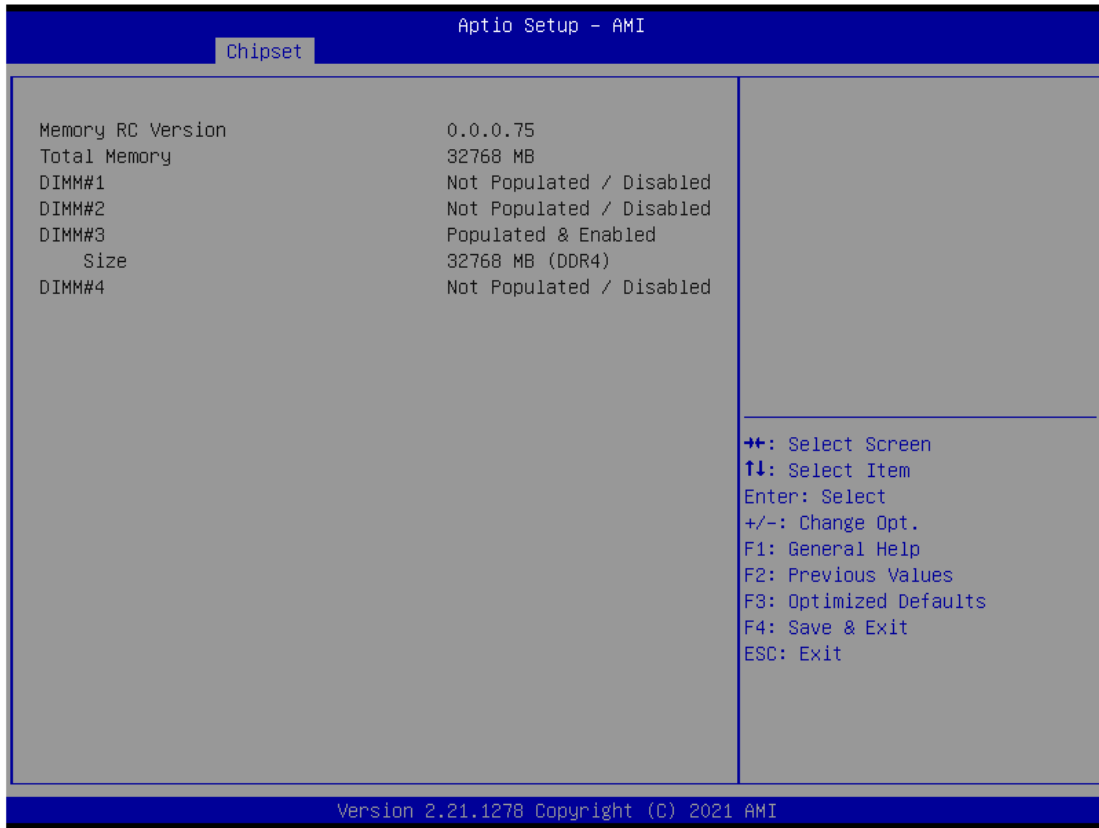

- **PEG Port Configuration**

Open the sub menu for parameters related to PEG port configuration.

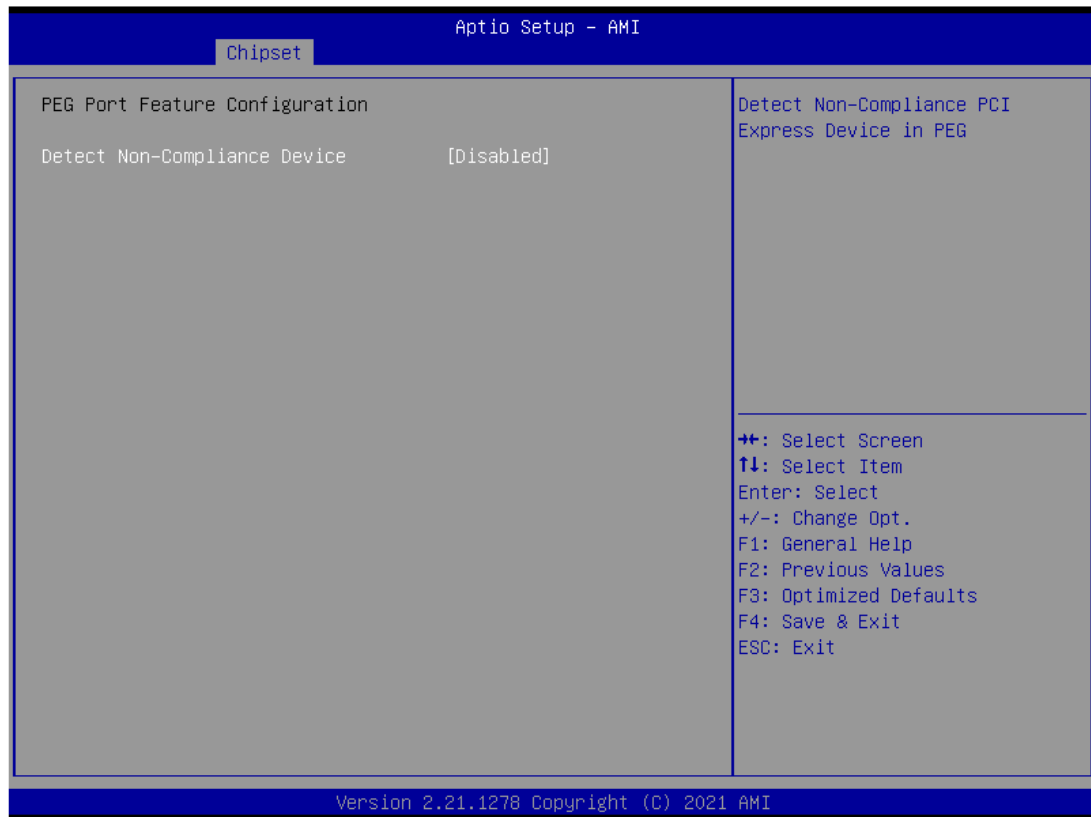

- **PCH-IO Configuration**

For items marked with “▶”, please press <Enter> for more options.

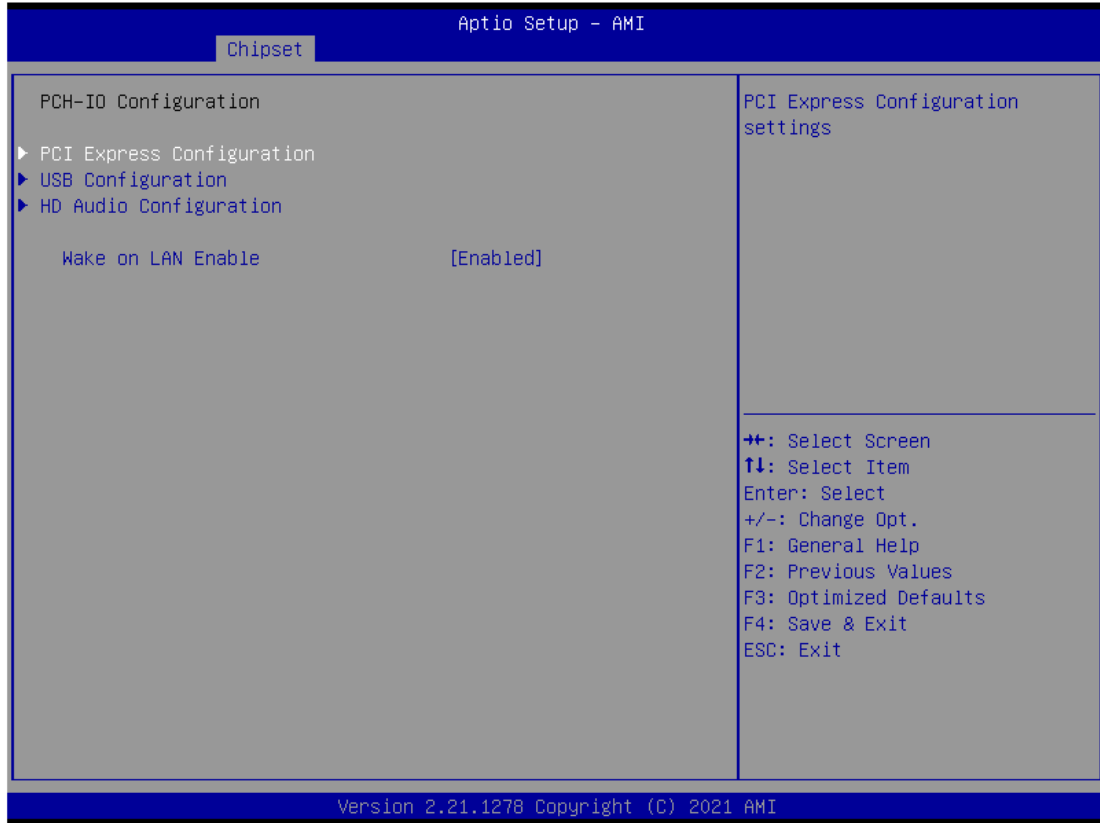

- **HD Audio Configuration**



- **PCI Express Configuration**

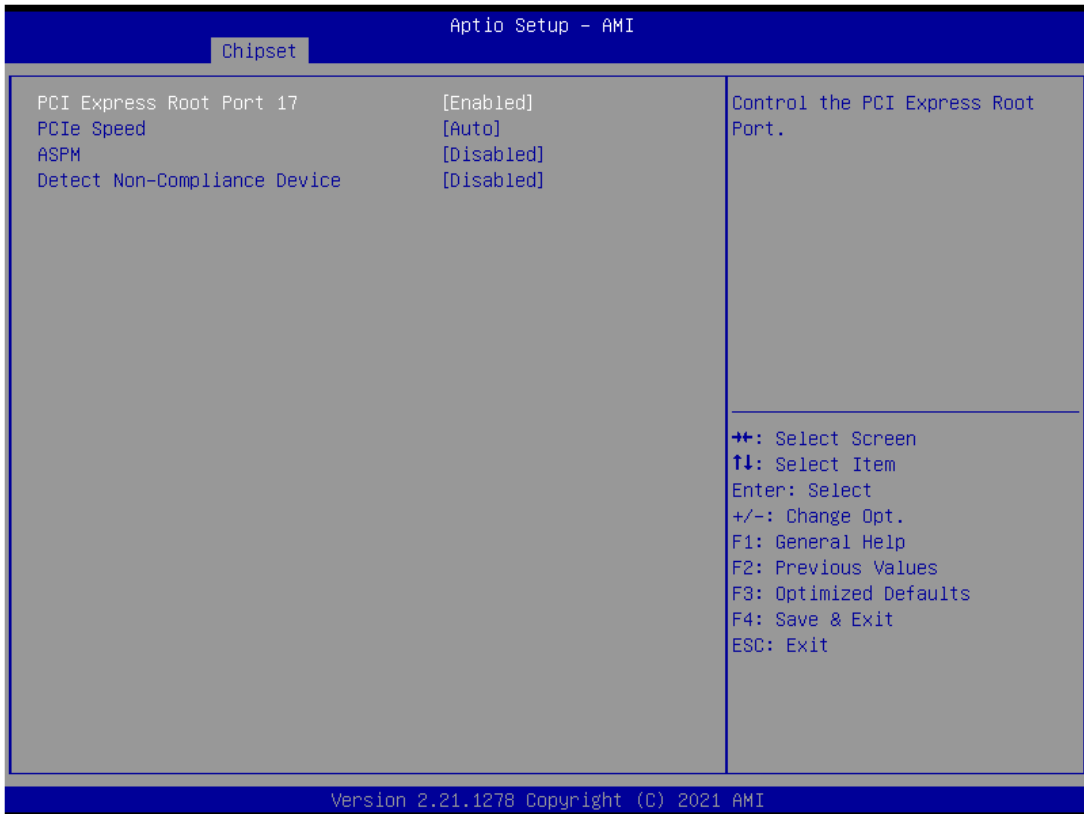
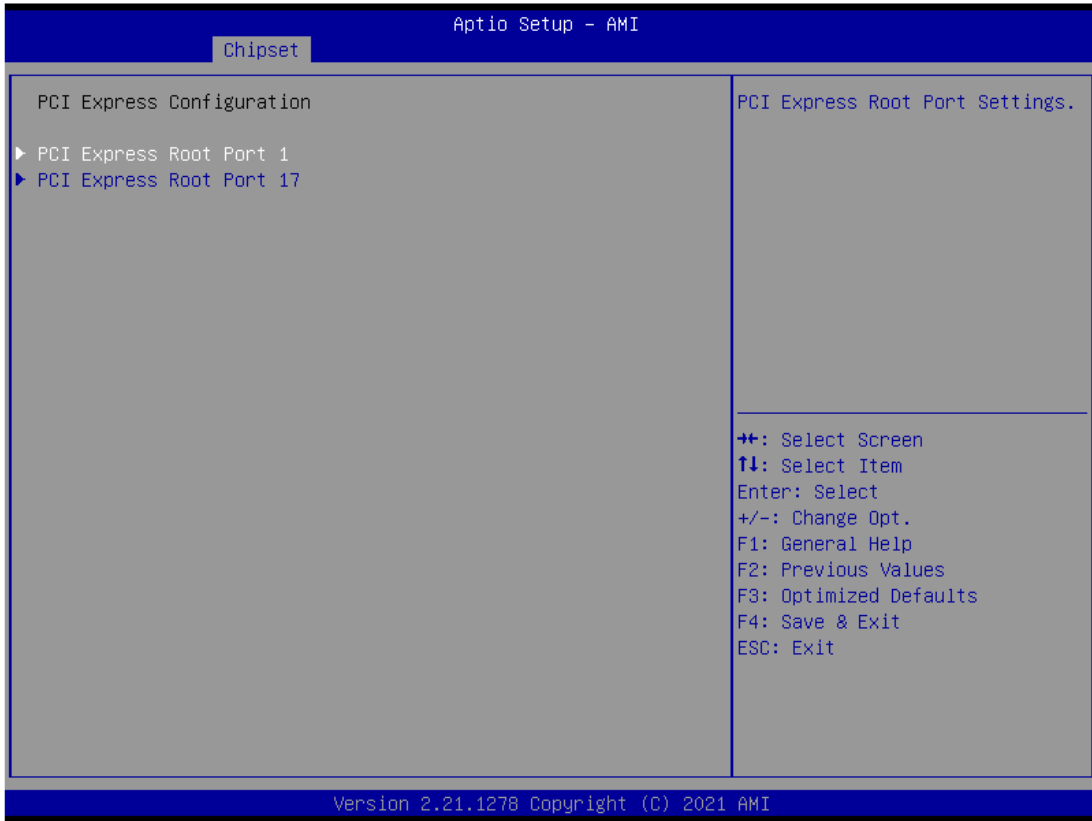



- **USB Configuration**

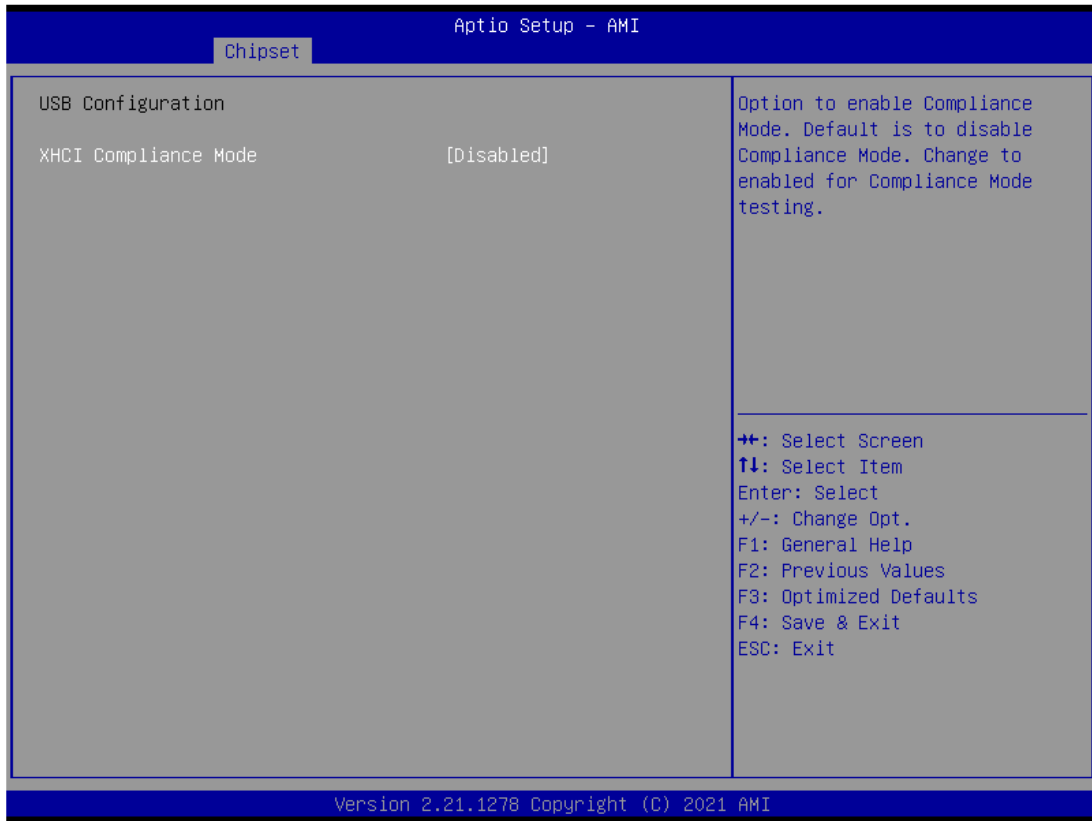

## 3.6 Security Menu

The Security menu allows users to change the security settings for the system.

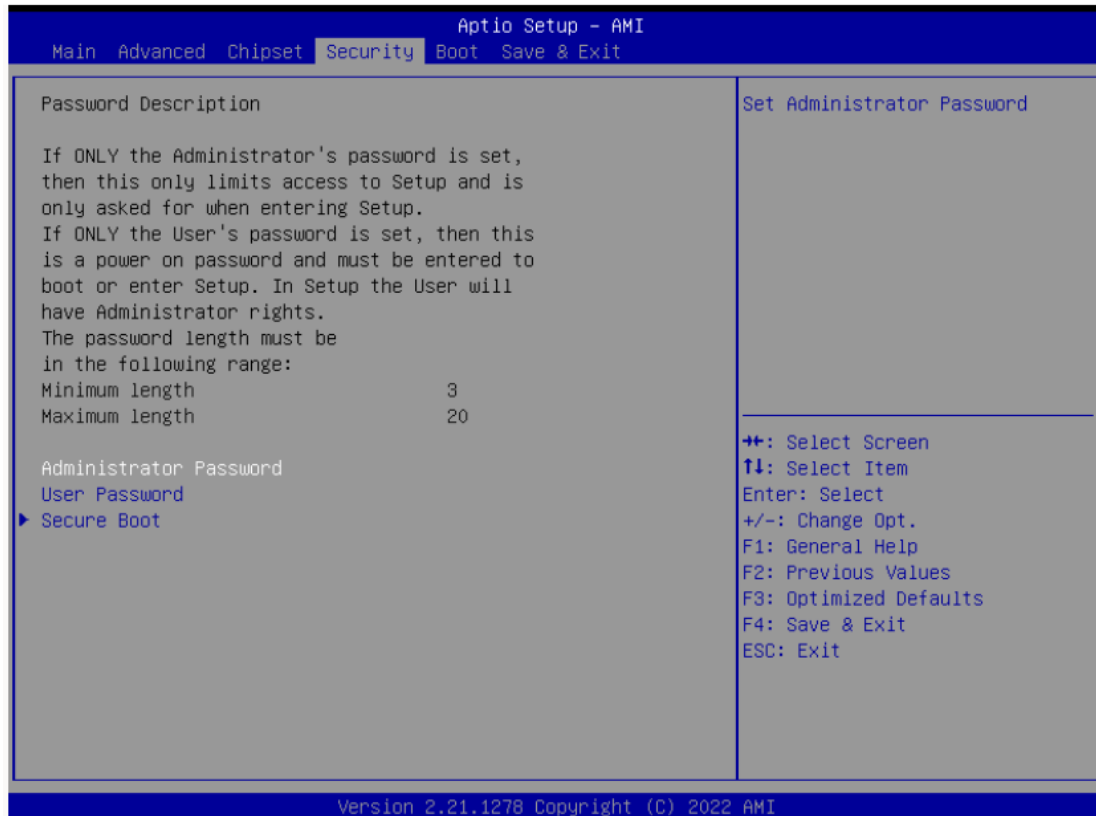

### ➤ Administrator Password

This item indicates whether an administrator password has been set (installed or uninstalled).

### ➤ User Password

This item indicates whether an user password has been set (installed or uninstalled).

## 3.7 Boot Menu

The Boot menu allows users to change boot options of the system.

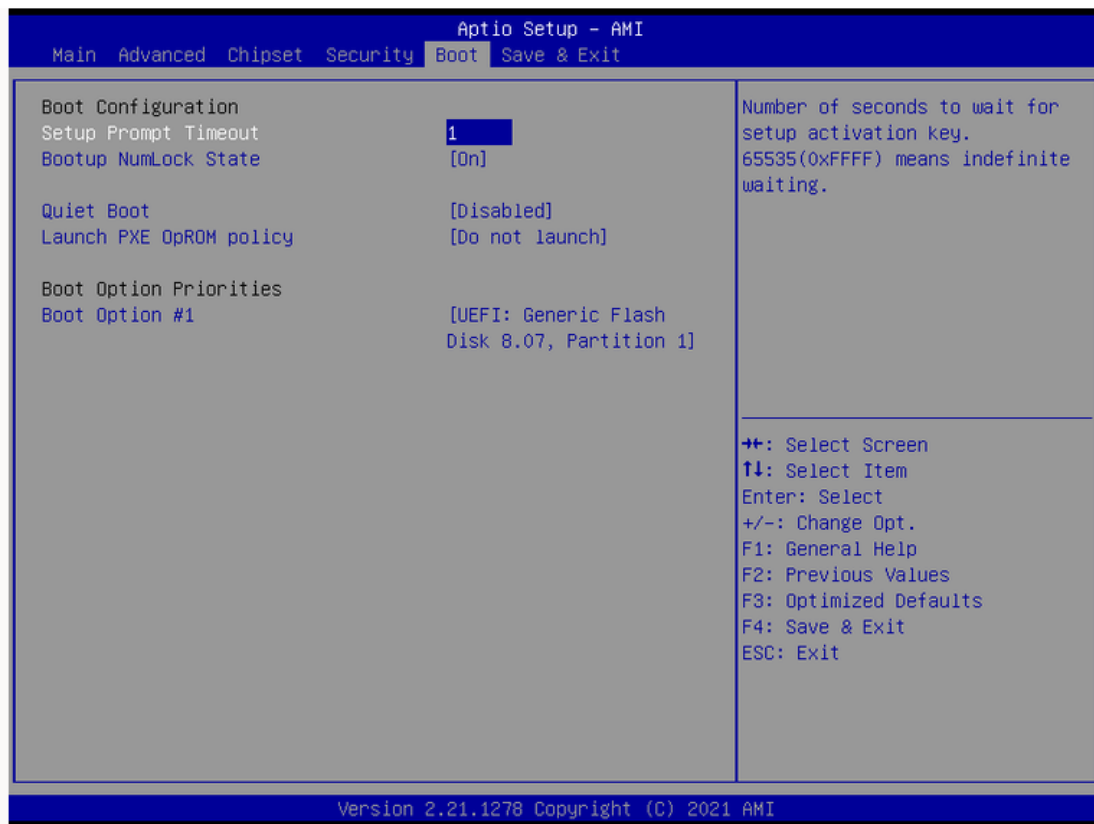

- **Setup Prompt Timeout**  
Set the number of seconds to wait for setup activation key. 65535(0xFFFF) means indefinite waiting.
- **Bootup NumLock State**  
Use this item to select the power-on state for the keyboard NumLock.
- **Quiet Boot**  
Select to display either POST output messages or a splash screen during boot-up.
- **Launch PXE OpROM policy**  
Use this item to enable or disable the boot ROM function of the onboard LAN chip when the system boots up.
- **Boot Option Priorities**  
These are settings for boot priority. Specify the boot device priority sequence from the available devices.

## 3.8 Save & Exit Menu

The Save & Exit menu allows users to load your system configuration with optimal or fail-safe default values.

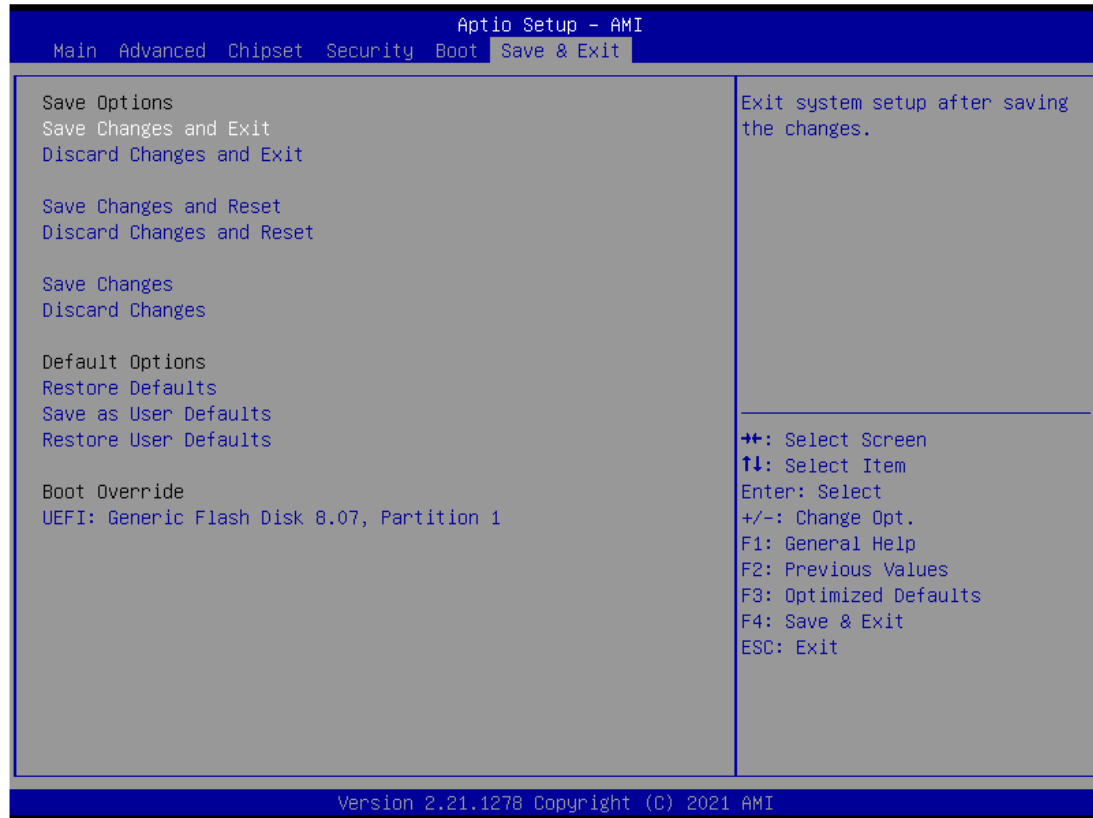

### ➤ Save Changes and Exit

When finishing the system configuration settings, select this option to leave Setup and return to Main Menu. Select Save Changes and Exit from the Save & Exit menu and press <Enter>. Select Yes to save changes and exit.

### ➤ Discard Changes and Exit

Select this option to quit Setup without making any permanent changes to the system configuration and return to Main Menu. Select Discard Changes and Exit from the Save & Exit menu and press <Enter>. Select Yes to discard changes and exit.

### ➤ Save Changes and Reset

When finishing the system configuration settings, select this option to leave Setup and reboot the computer so the new system configuration parameters can take effect. Select Save Changes and Reset from the Save & Exit menu and press <Enter>. Select Yes to save changes and reset.

---

➤ **Discard Changes and Reset**

Select this option to quit Setup without making any permanent changes to the system configuration and reboot the computer. Select Discard Changes and Reset from the Save & Exit menu and press <Enter>. Select Yes to discard changes and reset.

➤ **Save Changes**

When finishing the system configuration settings, select this option to save changes. Select Save Changes from the Save & Exit menu and press <Enter>. Select Yes to save changes.

➤ **Discard Changes**

Select this option to quit Setup without making any permanent changes to the system configuration. Select Discard Changes from the Save & Exit menu and press <Enter>. Select Yes to discard changes.

➤ **Restore Defaults**

After selecting this option, all the settings will be restored to defaults automatically. Select Restore Defaults from the Save & Exit menu and press <Enter>.

➤ **Save as User Defaults**

Select this option to save your current system configuration settings as User Defaults. Select Save as User Defaults from the Save & Exit menu and press <Enter>.

➤ **Restore User Defaults**

After selecting this option, all the settings will be restored to user defaults automatically. Select Restore User Defaults from the Save & Exit menu and press <Enter>.

➤ **Boot Override**

Select a drive to immediately boot that device regardless of the current boot order.

**This page is intentionally left blank.**

---

# APPENDIX A WATCHDOG TIMER

## A.1 About Watchdog Timer

Software stability is major issue in most application. Some embedded systems are not watched by human for 24 hours. It is usually too slow to wait for someone to reboot when computer hangs. The systems need to be able to reset automatically when things go wrong. The watchdog timer gives us solution.

The watchdog timer is a counter that triggers a system reset when it counts down to zero from a preset value. The software starts counter with an initial value and must reset it periodically. If the counter ever reaches zero which means the software has crashed, the system will reboot.

## A.2 Sample Program

```
#include "stdafx.h"
#include <windows.h>
#include <stdio.h>
#include <tchar.h>
#include <stdlib.h>

#ifdef _DEBUG
#define new DEBUG_NEW
#endif

#pragma comment (lib, "User32.lib" )

#define IDT_TIMER WM_USER + 200
#define _CRT_SECURE_NO_WARNINGS 1
#define setbit(value,x) (value |= (1<<x))
#define clrbit(value,x) (value &=~(1<<x))

HINSTANCE hinstLibDLL = NULL;
LONG WDTDATA = 0;
```

```
typedef ULONG(*LPFNDDLGETIOSPACE)(ULONG);
LPFNDDLGETIOSPACE lpFnDll_Get_IO;
typedef void(*LPFNDDLSETIOSPACE)(ULONG, ULONG);
LPFNDDLSETIOSPACE lpFnDll_Set_IO;

int _tmain(int argc, _TCHAR* argv[])
{
    int unit = 0;
    int WDTtimer = 0;
    if (hinstLibDLL == NULL)
    {
        hinstLibDLL = LoadLibrary(TEXT("diodll.dll"));
        if (hinstLibDLL == NULL)
        {
            //MessageBox("Load diodll dll error", "", MB_OK);
        }
    }
}
```



```

    if (hinstLibDLL)
    {
        IpFnDII_Get_IO =
(LPFNDLLGETIOSPACE)GetProcAddress(GetModuleHandle("diodll.dll"), "GetIoSpaceByte");
        IpFnDII_Set_IO =
(LPFNDLLSETIOSPACE)GetProcAddress(GetModuleHandle("diodll.dll"), "SetIoSpaceByte");
    }
    printf("Input Watch Dog Timer type, 1:Second ; 2:Minute :");
    scanf("%d",&unit);
    printf("\nInput Timer to countdown:");
    scanf("%d", &WDTtimer);
    printf("Start to countdown...");

    //==Enter MB Pnp Mode==
    IpFnDII_Set_IO(0x2e, 0x87);
    IpFnDII_Set_IO(0x2e, 0x87);
    IpFnDII_Set_IO(0x2e, 0x07);
    IpFnDII_Set_IO(0x2f, 0x07); //SET LDN 07
    //set LDN07 FA 10 to 11
    IpFnDII_Set_IO(0x2e, 0xFA);
    WDTDATA = IpFnDII_Get_IO(0x2f);
    WDTDATA = setbit(WDTDATA, 0);
    IpFnDII_Set_IO(0x2f, WDTDATA);
    if (unit == 1)
    {
        IpFnDII_Set_IO(0x2e, 0xF6);
        IpFnDII_Set_IO(0x2f, WDTtimer);

        //start watchdog counting
        IpFnDII_Set_IO(0x2e, 0xF5);
        WDTDATA = IpFnDII_Get_IO(0x2f);
        WDTDATA = setbit(WDTDATA, 5);
        IpFnDII_Set_IO(0x2f, WDTDATA);
    }
    else if (unit == 2)
    {
        //set WDT Timer

```



```
    IpFnDII_Set_IO(0x2e, 0xF6);
    IpFnDII_Set_IO(0x2f, WDTtimer);
    //set watchdog time unit to min
    IpFnDII_Set_IO(0x2e, 0xF5);
    WDTDATA = IpFnDII_Get_IO(0x2f);
    WDTDATA = setbit(WDTDATA, 3);
    IpFnDII_Set_IO(0x2f, WDTDATA);
    //start watchdog counting
    IpFnDII_Set_IO(0x2e, 0xF5);
    WDTDATA = IpFnDII_Get_IO(0x2f);
    WDTDATA = setbit(WDTDATA, 5);
    IpFnDII_Set_IO(0x2f, WDTDATA);
}
system("pause");
return 0;
}
```

---

## APPENDIX B WAKE ON LAN

### How to Set up Wake on LAN

Please follow the following steps to set up Wake on LAN on Windows 11.

1. Press “” w/ “S” or press “” on Windows desktop.
2. Enter “proset” in red area.

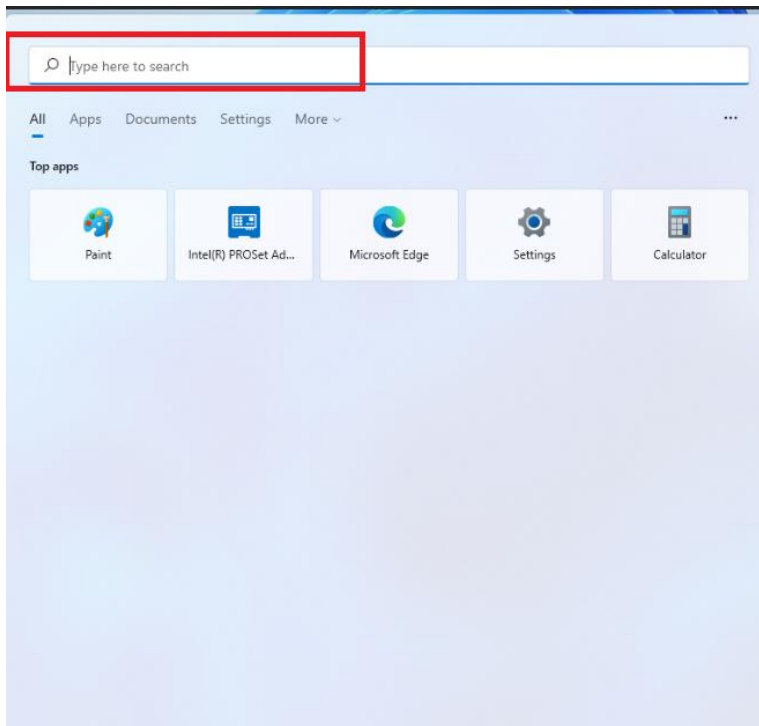

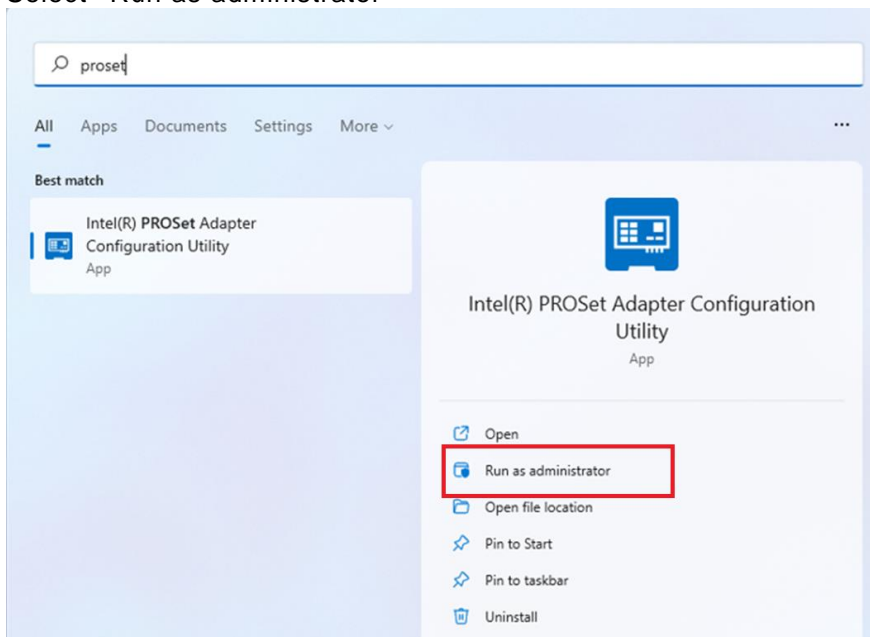

3. Select “Run as administrator”

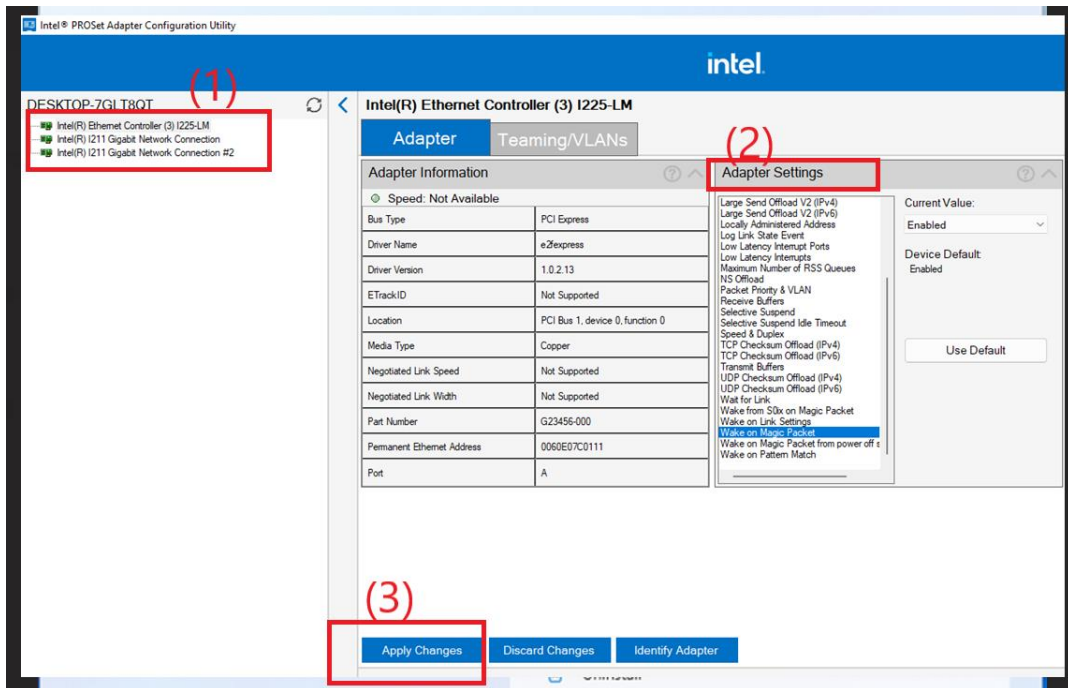

- Select a LAN port (1) which will support “Wake on LAN”, then enable functionality you need under “Adapter Settings” (2)
- Press “Any Changes” (3).



\*\*Please follow step 4 and step 5 to set the other LAN ports for “Wake on LAN”

- Press “ w/ “S” or press “” on Windows desktop.
- Enter “control panel” in red area.

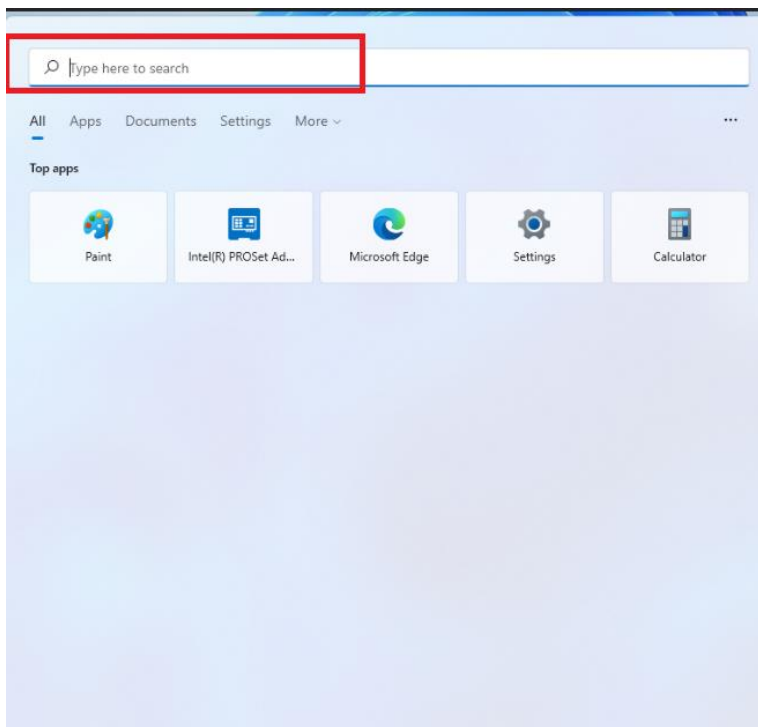

- Select “Open”.

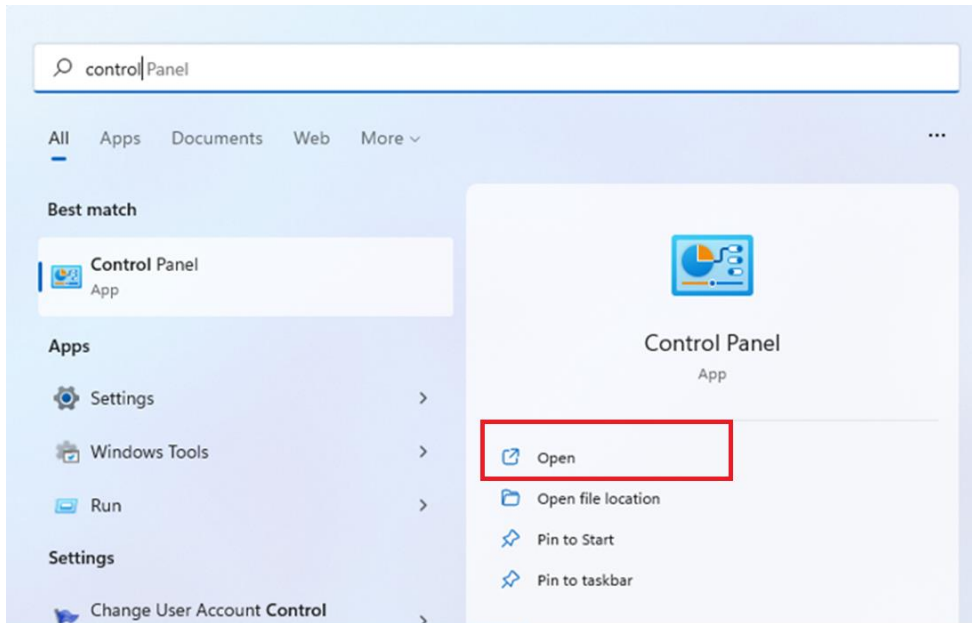

9. Press Power options → Change what the power button do

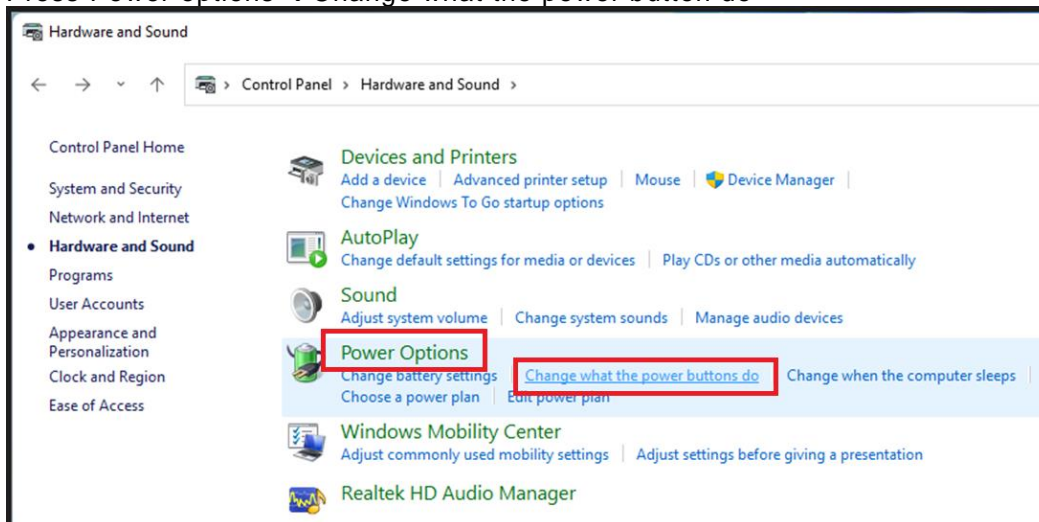

10. Remove “” from “Turn on fast startup”, then press “Save changes”.

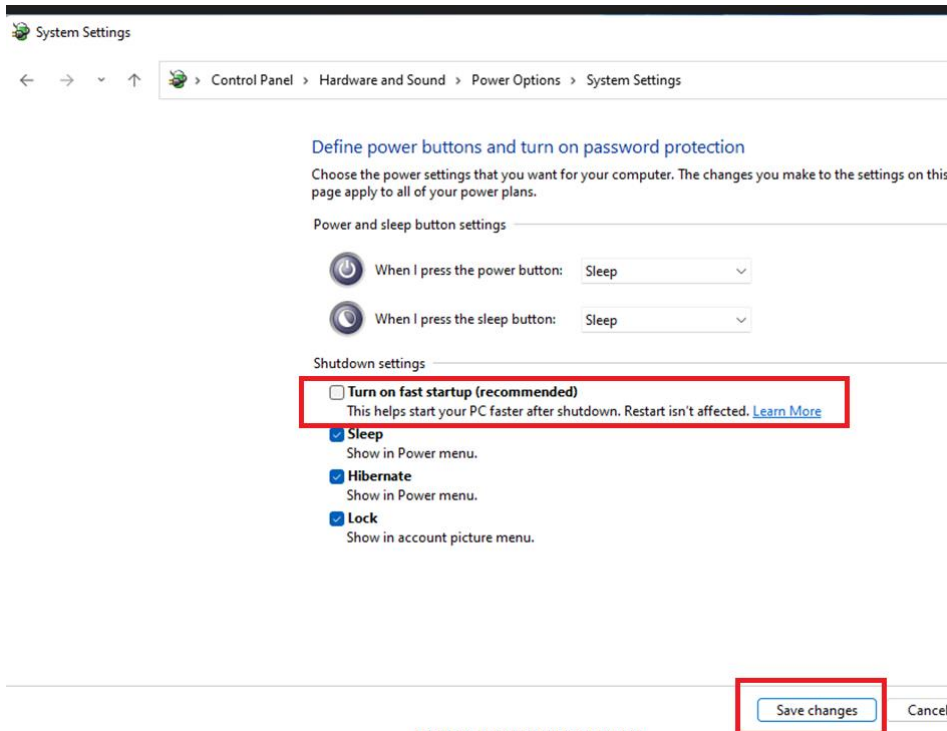

11. Reboot the system to enable the above settings. Installation is completed.