

# Table of Contents

---

Disclaimers.....	ii
Safety Precautions.....	iii
Classifications.....	iv
General Cleaning Tips .....	v
Scrap Computer Recycling.....	vi
<b>SECTION 1 INTRODUCTION.....</b>	<b>1</b>
1.1    General Descriptions .....	1
1.2    System Specifications .....	2
1.2.1    CPU .....	2
1.2.2    I/O System .....	3
1.2.3    System Specifications.....	4
1.2.4    Driver CD Contents.....	4
1.3    Dimensions .....	5
1.3.1    System Dimensions.....	5
1.3.2    Wall-mount Bracket Dimensions .....	6
1.4    I/O Outlets.....	7
1.5    Packing List.....	8
1.6    Model List .....	8
<b>SECTION 2 HARDWARE INSTALLATION .....</b>	<b>9</b>
2.1    Installation of CPU .....	9
2.2    Installation of 2.5" SATA Device .....	12
2.3    Installation of SO-DIMM.....	14
2.4    Installation of Mini PCIe Module (Full-size).....	15
2.5    Installation of Flexible I/O Modules .....	17
<b>SECTION 3 JUMPER &amp; CONNECTOR SETTINGS.....</b>	<b>19</b>
3.1    Locations of Jumpers & Connectors.....	19
3.2    Summary of Jumper Settings.....	21
3.3    Connectors.....	22
3.3.1    DC-in Phoenix Power Connector .....	22
3.3.2    HDMI Connector.....	23
3.3.3    DVI-D .....	24
3.3.4    VGA .....	24
3.3.5    Serial Port Connector(COM1~COM2) .....	25
3.3.6    Ethernet Connector (LAN1~LAN8).....	25
3.3.7    USB 3.0 Connector .....	26
3.3.8    USB 2.0 Connector .....	26
3.3.9    Audio Connector.....	27
3.3.10    Isolated Digital I/O .....	27
3.3.11    ATX Power On/OFF .....	27
3.3.12    Reset Button .....	27
3.3.13    SATA Connector (SATA 1~2).....	28
3.3.14    SATA Power Connector (CN18, CN19).....	28
3.3.15    SIM Card Slots (S1~S2).....	28
3.3.16    Full-Size PCI Express Mini Card Slot (CN10 & CN12).....	29
3.3.17    Half-Size Mini Card Slot (CN15 & CN16) .....	31
<b>SECTION 4 BIOS SETUP UTILITY .....</b>	<b>33</b>
4.1    Starting .....	33

4.2	Navigation Keys.....	33
4.3	Main Menu.....	34
4.4	Advanced Menu .....	35
4.5	Chipset Menu .....	49
4.6	Boot Menu.....	54
4.7	Save & Exit Menu .....	55
<b>APPENDIX A WATCHDOG TIMER .....</b>		<b>57</b>
	About Watchdog Timer .....	57
	Sample Program .....	57
<b>APPENDIX B DIGITAL I/O.....</b>		<b>59</b>
<b>APPENDIX C CONFIGURING SATA FOR RAID.....</b>		<b>63</b>

# SECTION 1 INTRODUCTION



This section contains general information and detailed specifications of the FL. Section 1 consists of the following sub-sections: -

- General Descriptions
- System Specifications
- Dimensions
- I/O Outlets
- Packing List
- Model List

## 1.1 General Descriptions

A fanless embedded system with 7<sup>th</sup> / 6<sup>th</sup> generation Intel® Core™ i7/i5/i3 and Celeron® processor (formally codename: KabyLake / Skylake) processor with flexible I/O design. To fulfill different application needs, the flexible embedded system supports WE8S, WES7, Windows® 10 and Linux, and it can be wall-mounted and Din-rail mounted by optional requests.

The is built with an IP40-rated heavy-duty aluminum extrusion, enabling reliable operation in harsh environments. Moreover, 24V DC power input with power protection, -40°C to +70°C extended temperature\*. To highly reduce deployment time, this fanless embedded PC supports one optional I/O door for customers to easily install additional I/O output. It is perfectly suitable for any industrial grade applications.

\*. Please refer to 1.2.3 to check the operation temperature specification by the corresponding processor.

## Features

- LGA1151 socket 7<sup>th</sup> / 6<sup>th</sup> generation Intel® Core™ i7/i5/i3 & Celeron® 35/65 watt processor (Kaby Lake / Skylake) with Intel®Q170
- Supports 8 channels gigabit PoE ports, IEEE802.3 af/at compliance
- Supports Jumbo Frame (9.5k), WoL, PXE Remote Boot, Teaming
- 24V DC power input with optional ignition feature supported
- Various of flexible I/O kit supported via Flexible I/O Window

## Reliable and Stable Design

The embedded system supports 7<sup>th</sup> / 6<sup>th</sup> generation Intel® Core™ i7/i5/i3 and Celeron® 35W or 65W processor, high flexibility and multi-functional design is the best solution for any industrial field applications.

## Flexible Connectivity

It comes with rich I/O interfaces including dual RS-232/422/485 ports, four USB 3.0 ports, two USB 2.0 ports, 6-in/2-out isolated digital I/O and eight GbE/PoE LAN ports.

## Embedded O.S. Supported

with 6<sup>th</sup> platform supports Win 7/8/10 and Linux; 7<sup>th</sup> platform can support Windows® 10 64 Bit and Linux only.

## Various Storage Supported

In terms of storage, supports two 2.5" SATA storage drive bay, and one mSATA device.

# 1.2 System Specifications

## 1.2.1 CPU

- **CPU**
  - LGA1151 socket 7<sup>th</sup> / 6<sup>th</sup> generation Intel® Core™ i7/i5/i3 & Celeron® processor, CPU TDP max. up to 35W/65W
  - Intel® Core™ i7-6700TE/ 7700T/7700 processor
  - Intel® Core™ i5-6500TE/ 7500T/7500 processor
  - Intel® Core™ i3-6100TE/ 7101TE processor
  - Intel® Celeron® G3900TE / G4400TE processor
- **Chipset**
  - Intel® Q170
- **BIOS**
  - American Megatrends Inc. UEFI (Unified Extensible Firmware Interface) BIOS.
- **System Memory**
  - Two 260-pin unbuffered DDR4-2133 MHz SO-DIMM socket, up to 32 GB at the maximum for 6<sup>th</sup> generation Intel® Core™ processor
  - Two 260-pin unbuffered DDR4-2400 MHz SO-DIMM socket, up to 32 GB at the maximum for 7<sup>th</sup> generation Intel® Core™ processor

## 1.2.2 I/O System

- **Display**

- 1 x HDMI (Resolution:4K/2K@60Hz)
- 1 x DVI-D (Resolution:4K/2K@60Hz)
- 1 x VGA (Resolution: 1920X1200 @60Hz)



**【Note】** : If users use HDMI /DVI monitor to install graphic driver, please press "win + P" to "Clone Displays mode" and from Intel Graphics Control Panel -> Multiple Displays -> select HDMI or DVI as the main screen.

- **Ethernet / Power over Ethernet**

- 8 x 10/100/1000 RJ45 Ethernet ports(8 x i211-AT)
- IEEE802.3af/at compliance, max. up to 90W for total 8-CH PoE

- **USB Ports**

- 4 x USB 3.0
- 2 x USB 2.0

- **Serial Ports**

- 2 x RS-232/422/485 (COM1~2)

- **DIO**

- Isolated 6 x DI and 2 x DO

- **Audio**

- 1 x Audio (Mic-in/Line-out)

- **Mini Card Interface**

- 2 x full-size PCI Express Mini Card Slots (USB + PCI Express)
- 1 x half-size PCI Express Mini Card Slots(mSATA + USB + PCI Express)
- 1 x half-size PCI Express Mini Card Slots(USB signal only)

- **Storage**

- 2 x 2.5" SATA HDD/SSD drive bay
- 1 x mSATA (enabled in DIP switch setting)

- **Indicator**

- 1 x Green LED as indicator for PWR status
- 1 x Green LED as indicator for HDD active
- 2 x Green LED as indicator for programmable LED

- **Switch**

- 1 x Power switch
- 1 x Reset switch

- **SIM & Antenna**

- 2 x Front-access SIM slot
- 4 x SMA type antenna opening

### 1.2.3 System Specifications

- **Watchdog Timer**
  - 1~255 seconds or minutes; up to 255 levels.
- **Power Supply**
  - 24VDC input by terminal block connector
- **Operation Temperature**
  - **35W Tj=100°C CPU:**  
-40°C to +70°C (-40°F to +158°F) with W.T. SSD & DRAM
  - **65W Tj=100°C CPU:**  
-40°C to +55°C (-40°F to +131°F) with W.T. SSD & DRAM
  - **35W Tj=80°C CPU:**  
-40°C to +50°C (-40°F to +122°F) with W.T. SSD & DRAM
- **Storage Temperature**
  - -40°C ~+85°C (-40 °F ~ 185°F)
- **Humidity**
  - 10% ~ 95% (non-condensation)
- **Vibration Endurance**
  - With SSD: 3Grm (5-500Hz, X, Y, Z directions)
- **Shock Test**
  - With SSD: 50 G, IEC 60068-2-27, half sine, 11 ms duration
- **Weight**
  - 4.31 kg (9.5 lb) without package
  - 5.1 kg (11.24 lb) with package
- **Dimension**
  - 280 mm (11.02") (W) x 210mm (8.26") (D) x 79.6 mm (3.13") (H)

### 1.2.4 Driver CD Contents

- Ethernet
- Chipset
- Graphic
- Serial Port
- USB 3.0
- Intel® ME
- Audio
- User Manual
- Quick Manual



**【 Note 】** : All specifications and images are subject to change without notice.

## 1.3 Dimensions

The following diagrams show dimensions and outlines of the

### 1.3.1 System Dimensions

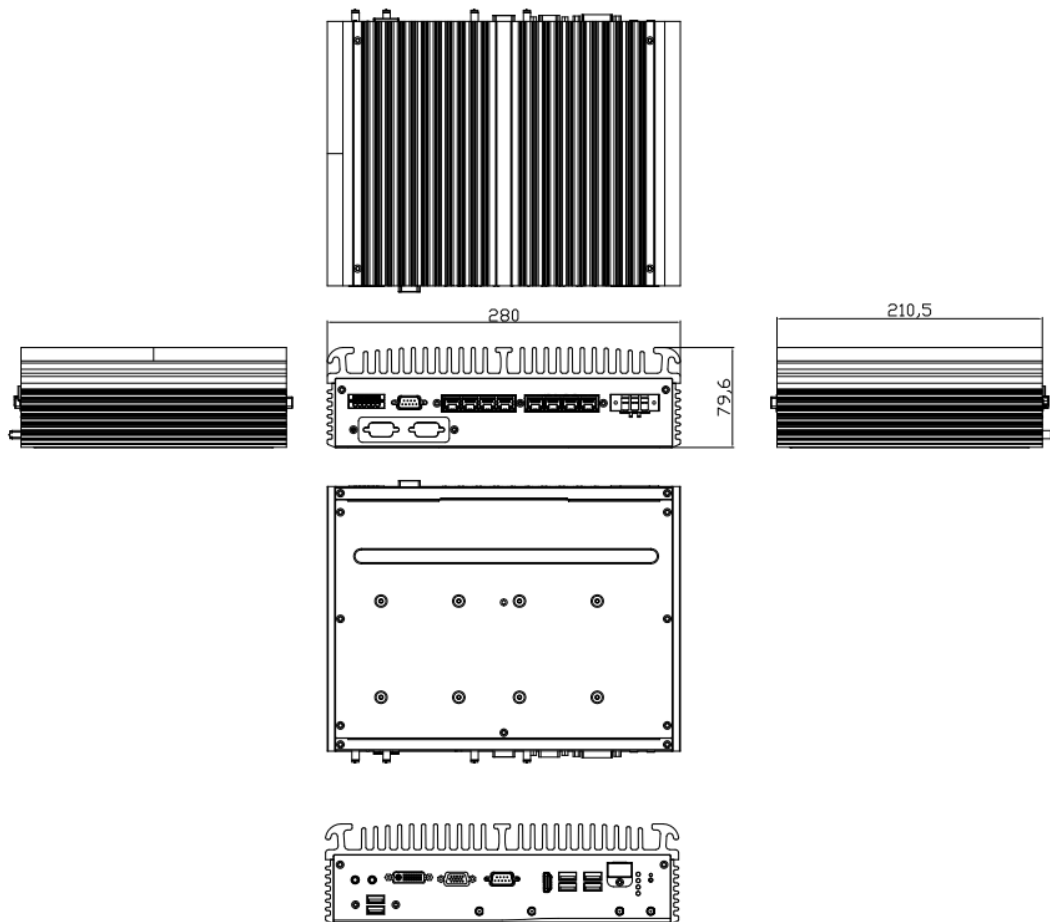

### 1.3.2 Wall-mount Bracket Dimensions

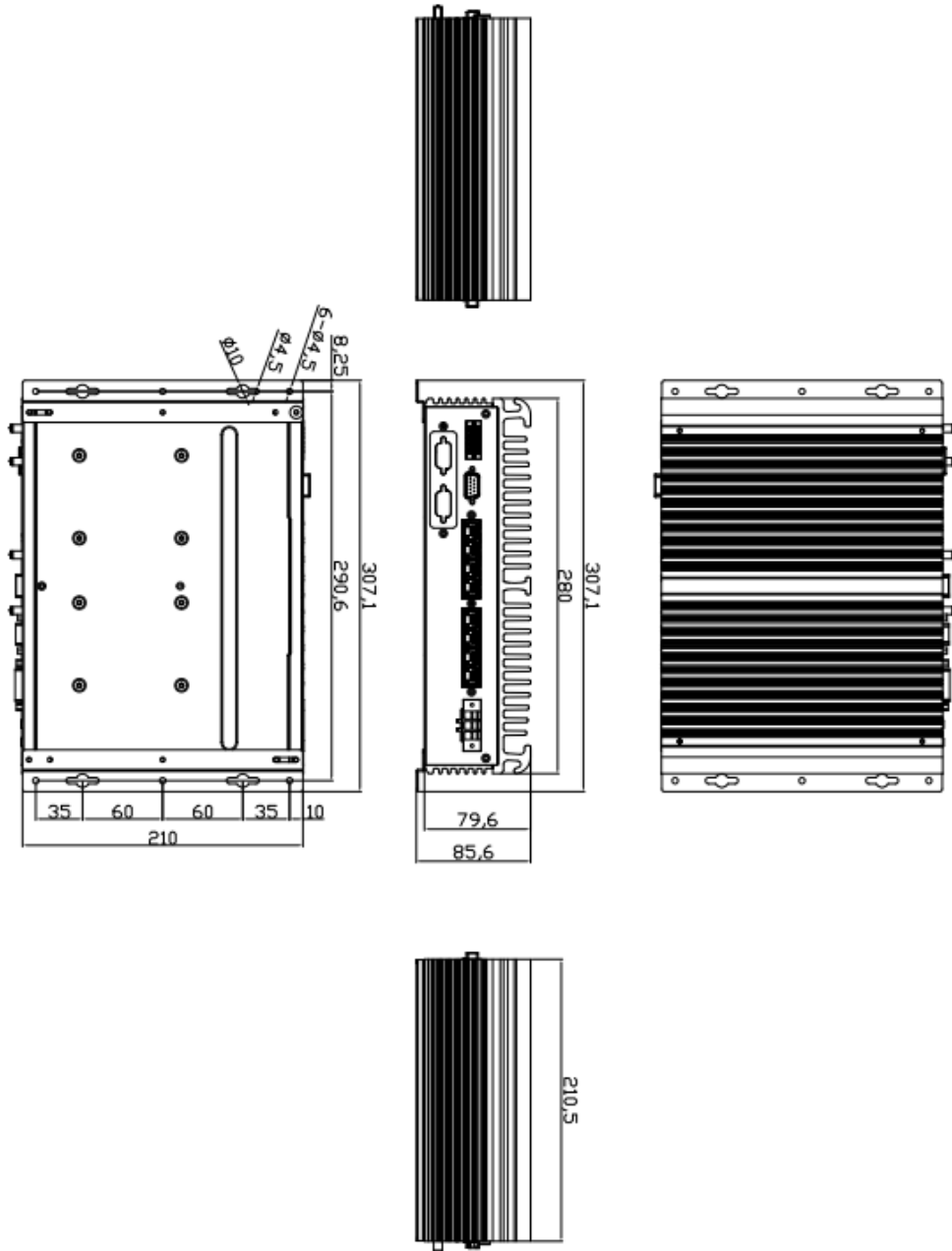



# 1.4 I/O Outlets

The following figures show I/O outlets on

## Front View

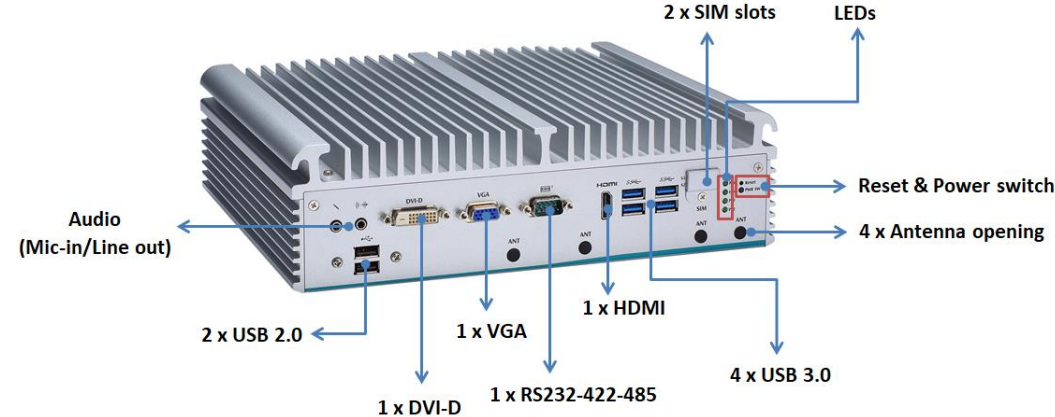

## Rear View

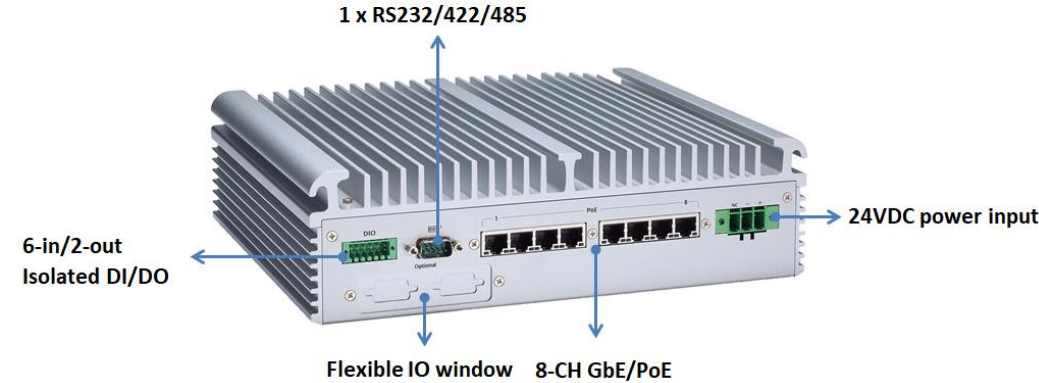

## 1.5 Packing List

comes with the following bundle package:

- **System Unit x 1**
- **DRAM Thermal Pad (3T) x 2**
- **Terminal Block (3P) x 1**
- **DIO Connector x 1**
- **CPU Grease x1**
- **Foot Pad x 4**
- **Screw pack x 1**

## 1.6 Model List

	Fanless embedded system with LGA1151 socket 7th/6th gen Intel® Core™ i7/i5/i3 & Celeron® processors, Intel® Q170, VGA, DVI-D, HDMI, 8-CH PoE, 6 USB and 24 VDC
--	--

## SECTION 2 HARDWARE INSTALLATION

is convenient for various hardware configurations, such as 35/65W CPU, DRAM, HDD (Hard Disk Drive), SSD (Solid State Drive) and PCI Express Mini card modules. Section 2 contains guidelines for hardware installation.

### 2.1 Installation of CPU

**Step 1** Turn off the system and unplug the power cord.

**Step 2** Loosen four screws to remove top cover.

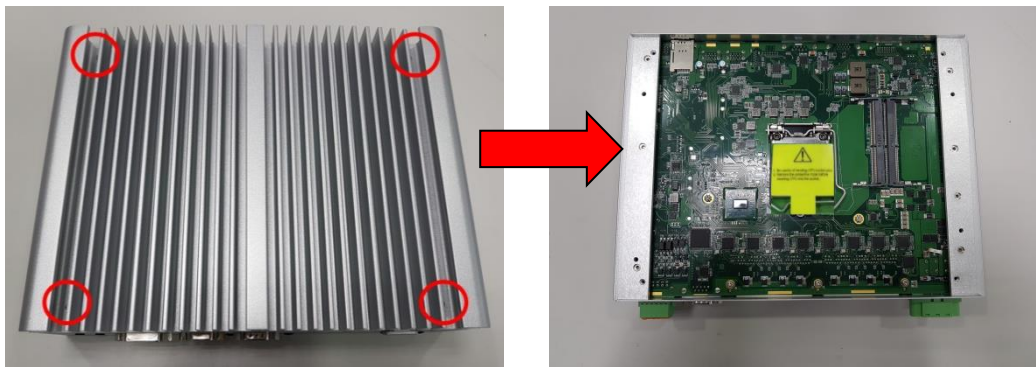

**Step 3** Remove the warning label and disengage load lever.

- Disengage load lever by releasing down and out on the hook.
- Rotate load lever to open position at approximately 135°.
- Rotate load plate to open position at approximately 150°.



Note

**Apply pressure to corner with right-hand thumb when opening or closing load lever - otherwise lever will bounce back (as a mouse trap) causing bent contacts.**

---

#### Step 4 CPU installation steps:

- Lift processor package from shipping media by grasping the substrate edges.



- Scan the processor package gold pads for any presence of foreign material.
- Locate connection 1 indicator on the processor which aligns with connection 1 indicator chamfer on the socket, and notice processor keying features that line up with posts along socket walls.
- Grasp the processor with thumb and index finger along the top and bottom edges. The socket will have cutouts for your fingers to fit into.
- Carefully place the processor into the socket body vertically.

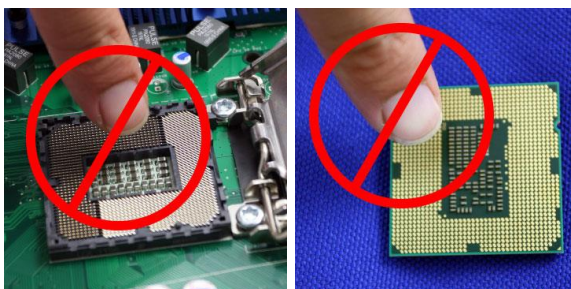
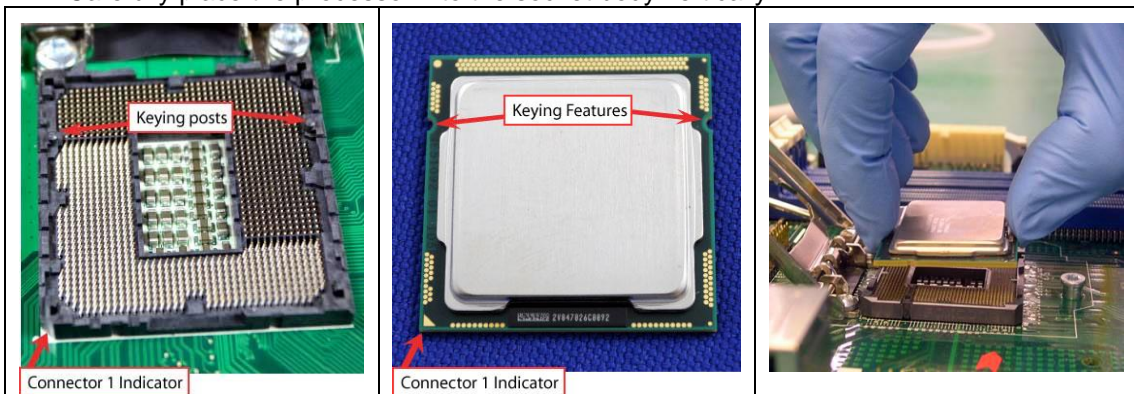

**Never touch fragile socket contacts to avoid damage and do not touch processor sensitive contacts at any time during installation.**

**Step 5** Align pins of the CPU with pin holes of the socket. Be careful of the CPU's orientation that user's need to align the arrow mark on the CPU with the arrow key on the socket.

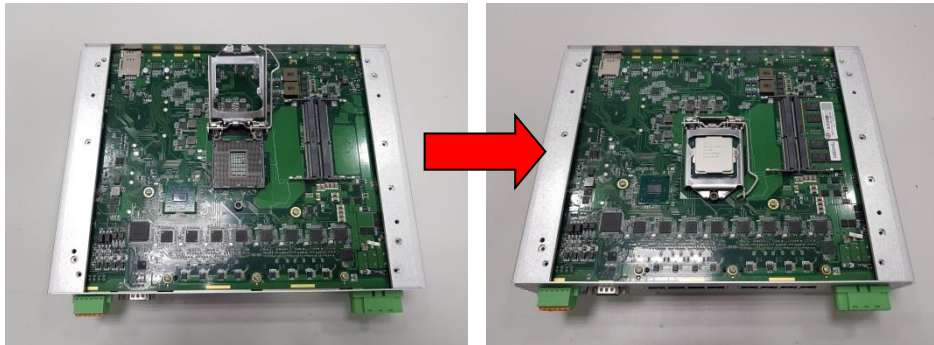

**Step 6** And apply the thermal grease evenly on top of the processor.



**Step 7** Put the top cover and fasten four screws back onto the system.



## 2.2 Installation of 2.5" SATA Device

- Step 1** Turn off the system and unplug the power cord.  
**Step 2** Turn the system upside down to locate seven screws at the bottom and then loosen all screws.

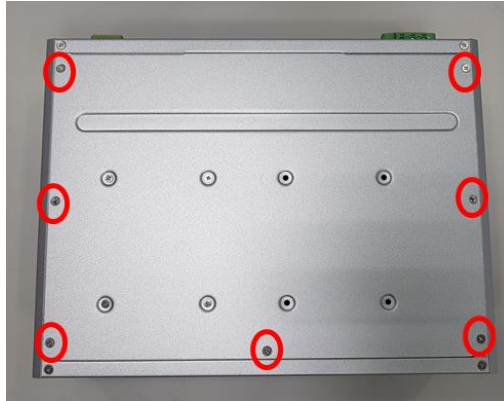

- Step 3** Open the bottom cover.  
**Step 4** Locate SSD/HDD within the red line as marked.  
Please notice the direction of connector for HDD.

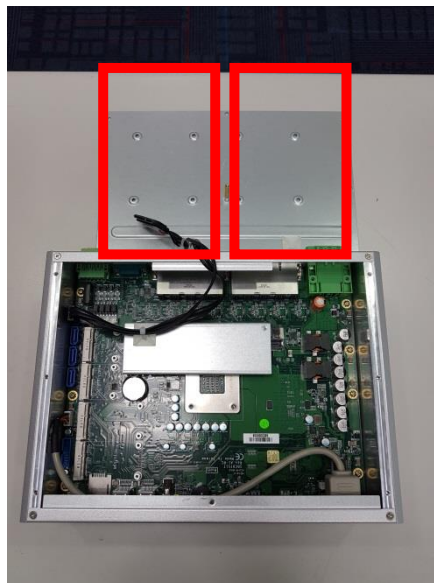

**Step 5 Assemble the SSD/HDD with the four HDD mounting screws. Make sure the PCB side of the SSD/HDD will be facing the bottom cover and connected the SATA power cable.**



**Step 6 Put the bottom cover and fasten all the screws back onto the system.**

## 2.3 Installation of SO-DIMM

**Step 1** Turn off the system and unplug the power cord.

**Step 2** Loosen four screws to remove top cover.

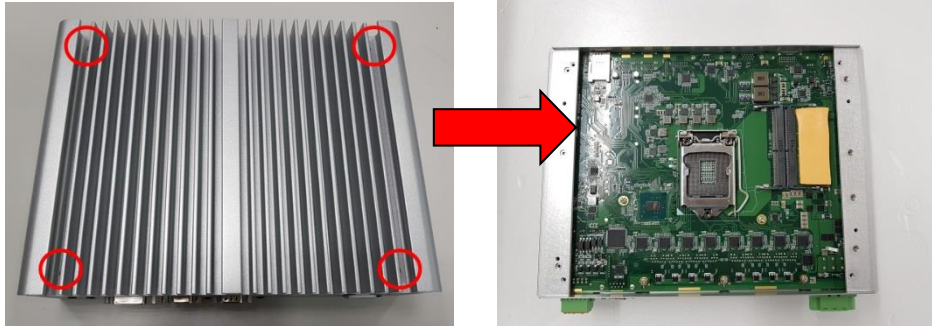

**Step 3** Located the dual SO-DIMM sockets on main board.

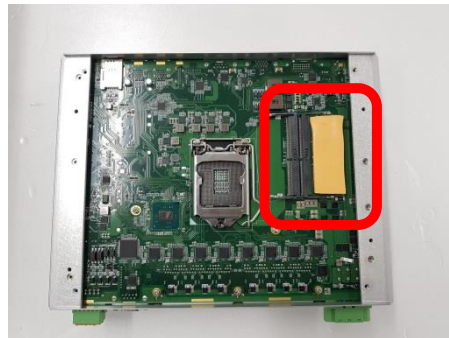

**Step 4** Locate the memory module, insert a gold colored contact into the socket and push the module two end latches till locked and put the top DRAM thermal pad from accessory pack onto the top of DRAM.

※Please notice that our SO-DIMM socket already installed thermal pad on bottom side to be our standard, users must to remove the mylar of thermal pad then install the corresponding DRAM into the socket, then refer to above step to paste top thermal pad (Dimension: 3T, from accessory pack) to complete the DRAM installation.

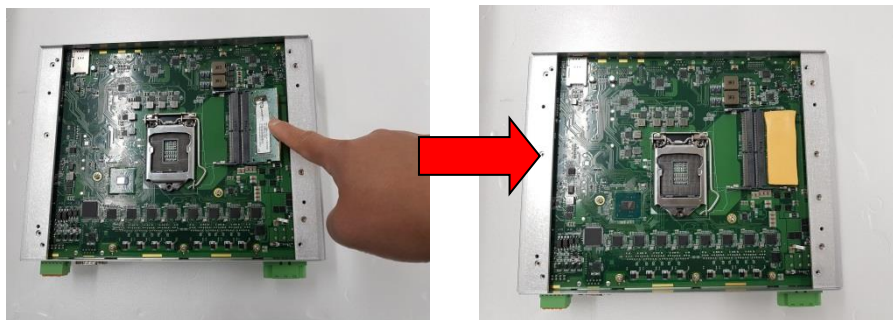

**Step 5** Put the top cover and fasten four screws back onto the system.



## 2.4 Installation of Mini PCIe Module (Full-size)

- Step 1** Turn off the system and unplug the power cord.  
**Step 2** Turn the system upside down to locate screws at the bottom, and then loosen all screws.

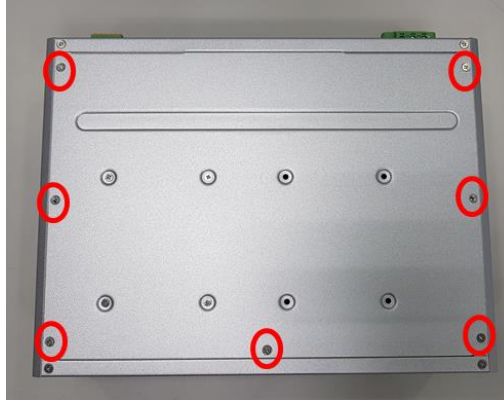

- Step 3** Identify the two full-size mPCIe and two half-size mPCIe slots, insert your corresponding mPCIe module into the sockets and then fasten all screws.

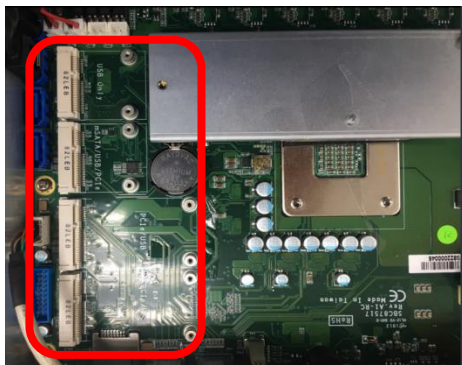

- Step 4** Put the bottom cover and fasten two screws back onto the system.

- supports dual SIM slots (SI & S2), if you would like to install WWAN module into , you must to follow the below table to insert SIM card to corresponding mini PCIe interface.

SIM Slot 1 / S1	Full-size mini PCIe - CN10
SIM Slot 2 / S2	Full-size mini PCIe - CN12

※ Loosen the SIM cover screws and insert the SIM card.

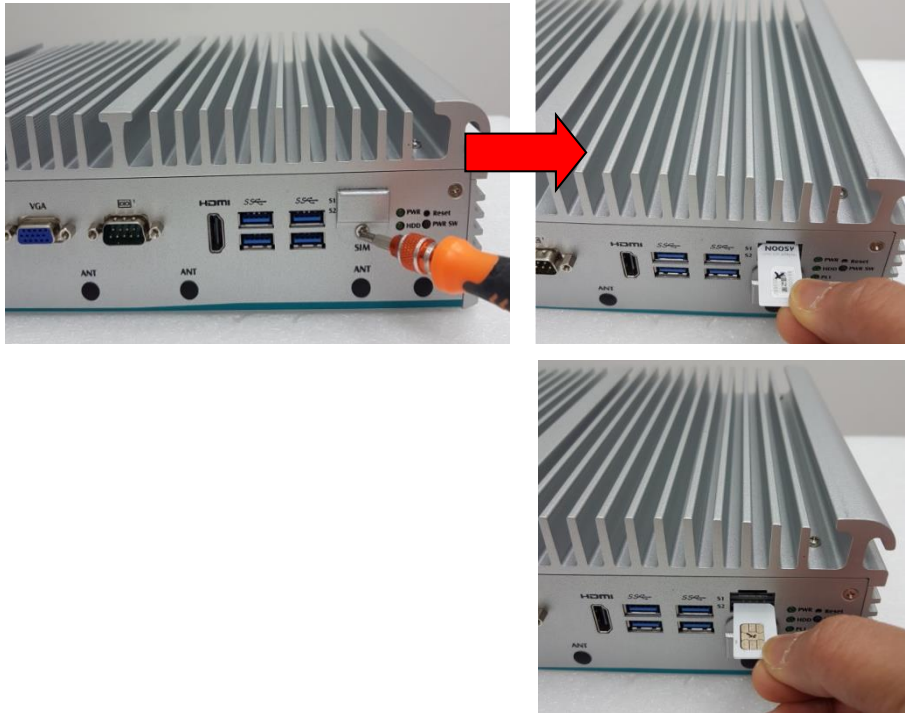

**【Note】** *The system provides two PCIe slots for SIM card installation. Pay attention to the orientation when inserting a SIM card: The SIM card's contacts must face downward when the card is being inserted into the SIM1 slot; the card's contacts must face upward when it is being inserted into the SIM2 slot.*

## 2.5 Installation of Flexible I/O Modules

provides an optional window for customer add flexible I/O modules, according to different modules , please refer to quick manual

- 1CH LAN Module (RJ45\*1)
- 32CH DIO Module (DB44\*1) \*
- CAN Bus/CAN Open Module (DB9\*2)
- 2CH RS-232 w/ half size mPCIe Module (DB9\*2)

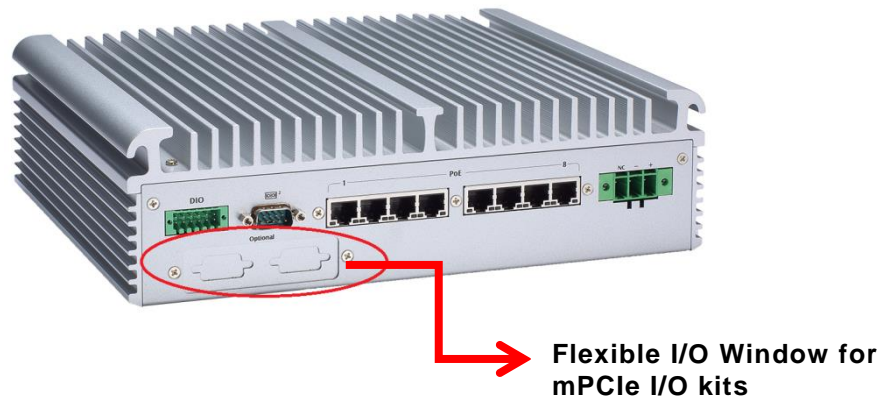

**Steps 1 Prepare the flexible I/O kit as below photo.**

**EX: CAN Bus Module Kit**



**Step 2 Turn off the system and unplug the power cord.**

**Step 3 Open the bottom cover.**

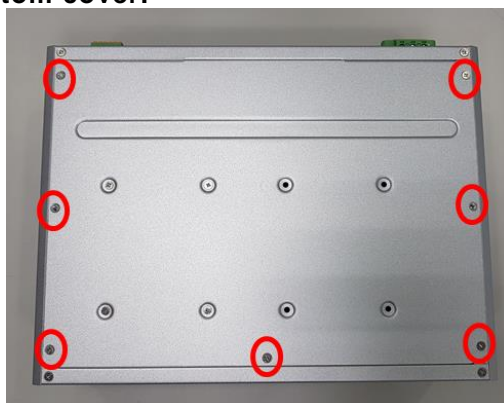

**Step 4 Insert the mini PCIe I/O card.**



**Step 5 Assemble I/O connector with bracket and fix this I/O bracket into the Flexible I/O Window**

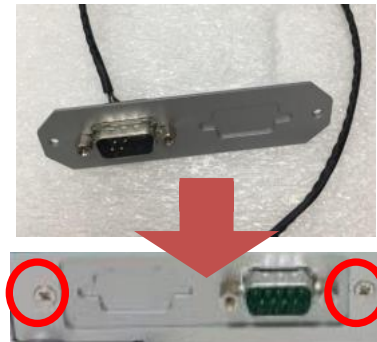

**Step 6 Put the bottom cover and fasten two screws back onto the system.**



**【Note】** *Please be informed that the system might get I/O conflicted issue if you install two types of mPCIe module which have compatible issue into this system; we suggest to replace another module kit to avoid this kind of issues.*

## SECTION 3 JUMPER & CONNECTOR SETTINGS

Proper jumper settings configure to meet various application needs. Hereby all jumpers settings along with their default settings are listed for devices onboard.

### 3.1 Locations of Jumpers & Connectors

SBC87517 Top View

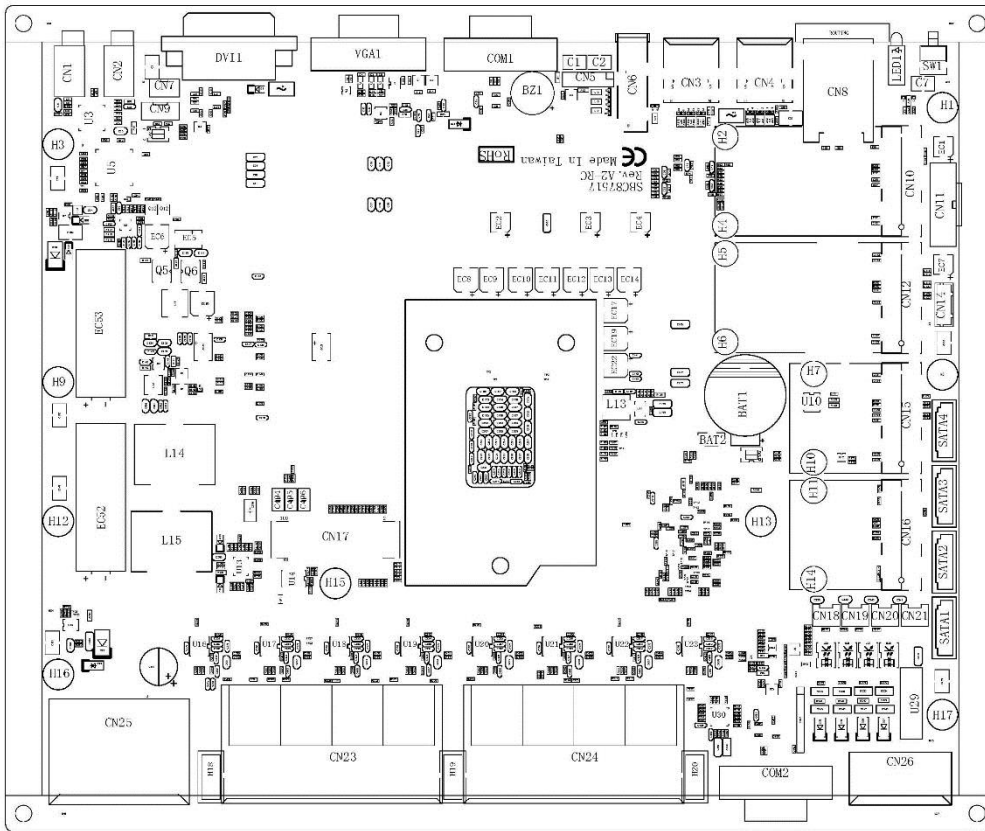

SBC87517 Bottom View

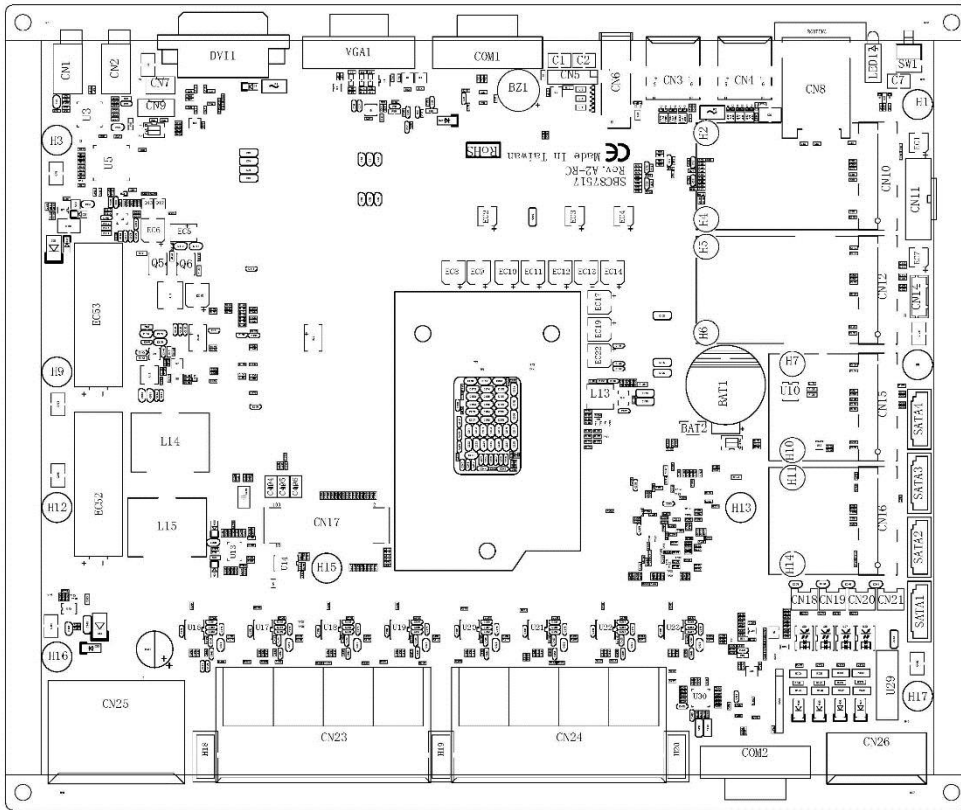

### 3.2 Summary of Jumper Settings

Proper DIP switch settings configure the to meet various application purposes. Hereby all jumper settings along with their default settings are listed for devices onboard.

SW2	Descriptions	Settings
SW2_PIN1	For CN15 mSATA mode (Optional)	ON
SW2_PIN1	For CN15 PCIe mode (Default setting)	OFF
SW2_PIN2	Restore BIOS Optimal Defaults	ON
SW2_PIN2	BIOS Normal Operation (Default Setting)	OFF

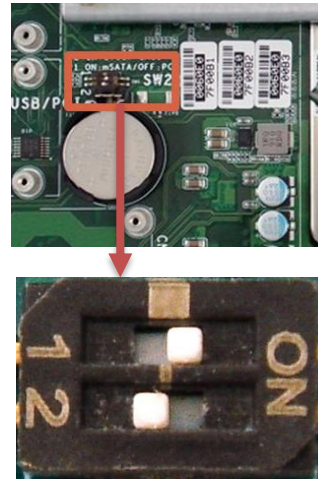

CN7	Descriptions	Settings
CN7 (1-2)	AT Mode: Enable auto power on	ON
CN7 (2-3)	ATX Mode: Disable auto power on (Default)	OFF

### 3.3 Connectors

Please refer to pin assignments below:

External Connectors	Sections
DC-in Phoenix Power Connector	3.3.1
HDMI Connector	3.3.2
DVI-D Connector	3.3.3
VGA	3.3.4
Serial Port Connector	3.3.5
Ethernet Connector	3.3.6
USB 3.0 Connector	3.3.7
USB 2.0 Connector	3.3.8
Audio Connector	3.3.9
Isolated Digital I/O Connector	3.3.10
ATX Power On/Off Button	3.3.11
Rest Button	3.3.12
Internal / External Connectors	Sections
Serial ATA (SATA1~2) Connector	3.3.13
SATA Power Connector (CN18, CN19)	3.3.14
SIM Card Slot (S1~S2)	3.3.15
Full-Size Express Mini Card slot (CN10,CN12)	3.3.16
Half-Size Express Mini Card slot (CN15,CN16)	3.3.17

#### 3.3.1 DC-in Phoenix Power Connector

The system supports the 24V Phoenix DC-in connector for system power input.

ACC/ ignition feature supported by optional SKU.

Pins	Signals
1	DC+
2	DC-
3	NC

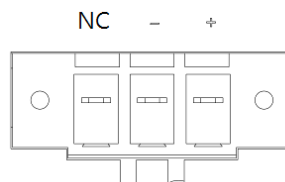



### 3.3.2 HDMI Connector

The HDMI (High-Definition Multimedia Interface) is a compact digital interface which is capable of transmitting high-definition video and high-resolution audio over a single cable.

Pins	Signals	Pins	Signals
1	HDMI OUT_DATA2+	11	GND
2	GND	12	HDMI OUT Clock-
3	HDMI OUT_DATA2-	13	N.C.
4	HDMI OUT_DATA1+	14	N.C.
5	GND	15	HDMI OUT_SCL
6	HDMI OUT_DATA1-	16	HDMI OUT_SDA
7	HDMI OUT_DATA0+	17	GND
8	GND	18	+5V
9	HDMI OUT_DATA0-	19	HDMI_HTPLG
10	HDMI OUT Clock+		

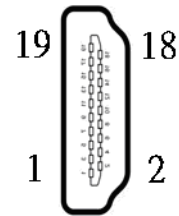

### 3.3.3 DVI-D

Pins	Signals	Pins	Signals	Pins	Signals
1	TMDS Data 2-	9	TMDS Data 1-	17	TMDS Data 0-
2	TMDS Data 2+	10	TMDS Data 1+	18	TMDS Data 0+
3	GND	11	GND	19	GND
4	No use	12	N.C	20	N.C
5	No use	13	N.C	21	N.C
6	DVI_SPD_Clock	14	+5V	22	GND
7	DVI_SPD_Data	15	GND	23	TMDS Clock+
8	No use	16	Hot Plug Detect	24	TMDS Clock-
C1	No use	C2	No use	C4	No use
C3	No use	C5	GND		

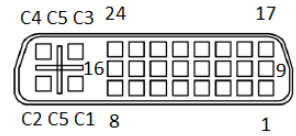

### 3.3.4 VGA

Pins	Signals	Pins	Signals	Pins	Signals
1	Red	6	GND	11	N.C.
2	Green	7	GND	12	DDC DATA
3	Blue	8	GND	13	Horizontal Sync
4	N.C.	9	VCC	14	Vertical Sync
5	GND	10	GND	15	DDC CLK

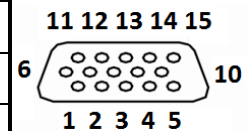

### 3.3.5 Serial Port Connector(COM1~COM2)

The system has four serial ports. COM1~COM2 are RS-232/422/485 ports. Please refer to Chapter 4 for detailed BIOS settings.

Pins	RS-232	RS-422	RS-485
1	DCD, Data carrier detect	TX-	Data-
2	RXD, Receive data	TX+	Data+
3	TXD, Transmit data	RX+	NC
4	DTR, Data terminal ready	RX-	NC
5	GND, ground	GND	GND
6	DSR, Data set ready	NC	NC
7	RTS, Request to send	NC	NC
8	CTS, Clear to send	NC	NC
9	RI, Ring indicator	NC	NC

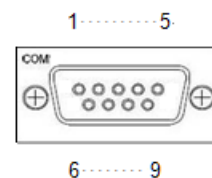

### 3.3.6 Ethernet Connector (LAN1~LAN8)

supports eight RJ-45 connectors for LAN1~LAN8 Ethernet (Intel i211-AT) connectivity and these 8-CH GbE also support Power over Ethernet (PoE) feature; IEEE802.3af/at compliance, max. up to 90W for power device.

Pins	LAN Signal	Pins	LAN Signal
L1	MDI0+	L5	MDI2+
L2	MDI0-	L6	MDI2-
L3	MDI1+	L7	MDI3+
L4	MDI1-	L8	MDI3-
A	Activity link LED (Orange) OFF: No link Blinking: Link established; data activity detected		
B	PoE LED Green: PoE Activity LED		

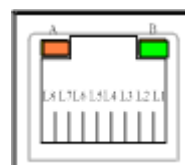

### 3.3.7 USB 3.0 Connector

The Universal Serial Bus connectors are compliant with USB 3.0 (5 GB/s), ideal for connecting USB peripherals such as scanners, cameras and other USB devices.

Pins	Signal USB Port 0	Pins	Signal USB Port 1
1	USB_VCC (+5V level standby power)	10	USB_VCC (+5V level standby power)
2	USB_Data-	11	USB_Data-
3	USB_Data+	12	USB_Data+
4	GND	13	GND
5	SSRX-	14	SSRX-
6	SSRX+	15	SSRX+
7	GND	16	GND
8	SSTX-	17	SSTX-
9	SSTX+	18	SSTX+

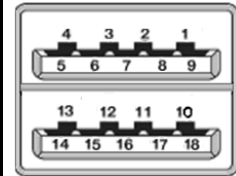

### 3.3.8 USB 2.0 Connector

The Universal Serial Bus connectors are compliant with USB 2.0 (480Mbps), and ideally for installing USB peripherals such as keyboard, mouse, scanner, etc.

Pins	Signal USB Port
1	USB VCC (+5V level)
2	USB #0_D-
3	USB #0_D+
4	Ground (GND)

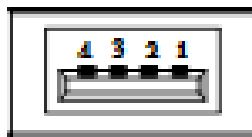

### 3.3.9 Audio Connector

These two audio jacks ideal are for Audio Mic-In and Audio Line-out.

Pins	Signals
1	Microphone In
2	Line Out

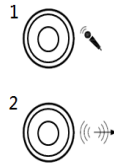

### 3.3.10 Isolated Digital I/O

supports an isolated 6-in/2-out Digital I/O (DIO)

Pins	Signals	Pins	Signals
1	COM+	7	IN 0
2	OUT0	8	IN 1
3	OUT1	9	IN 2
4	COM-	10	IN 3
5	DIO_GND	11	IN 4
6	Ext Power	12	IN 5

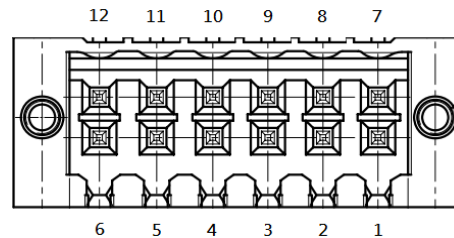

**NOTE:** Please refer to Appendix B for more information about Digital I/O

### 3.3.11 ATX Power On/OFF

The ATX power button is on the I/O side. It allows users to control power on/off state of the

Functions	Descriptions
On	Turn on/off system
Off	Keep system status



### 3.3.12 Reset Button

The reset button allows users to reset

Functions	Descriptions
On	Reset system
Off	Keep system status



### 3.3.13 SATA Connector (SATA 1~2)

These Serial Advanced Technology Attachment (Serial ATA or SATA) connectors are for high-speed SATA interfaces. They are computer bus interfaces for connecting to devices such as hard disk drives. This board has two SATA 3.0 ports with 6Gb/s performance.

Pins	Signals
1	GND
2	SATA_TX+
3	SATA_TX-
4	GND
5	SATA_RX-
6	SATA_RX+
7	GND

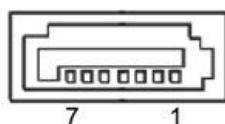

### 3.3.14 SATA Power Connector (CN18, CN19)

Use CN18 · CN19 for interfacing to SATA 2.5" HDD power supply.

Pins	Signals
1	+5V level
2	GND

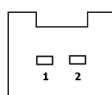

### 3.3.15 SIM Card Slots (S1~S2)

There are dual SIM slots on the front side of the system for inserting SIM Card. It is mainly used in 3G/LTE wireless network application on CN12 (for S2) and CN10 (for S1).

Pins	Signals
1	PWR
2	RST
3	CLK
4	GND
5	GND
6	VPP
7	I/O
8	GND

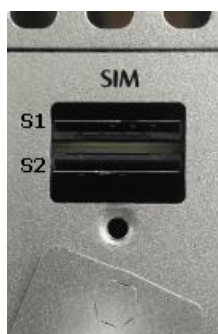

### 3.3.16 Full-Size PCI Express Mini Card Slot (CN10 & CN12)

supports dual full-size PCI-Express Mini Card slots. CN10 and CN12 apply to either PCI-Express or USB 2.0 signals, and comply with PCI-Express Mini Card Spec. V1.2.

#### CN10

Pins	Signals	Pins	Signals
1	WAKE#	2	+3.3VSB
3	No use	4	GND
5	No use	6	+1.5V
7	No use	8	SIM S2_PWR
9	GND	10	SIM S2_I/O
11	REFCLK-	12	SIM S2_CLK
13	REFCLK+	14	SIM S2_RST
15	GND	16	SIM S2_VPP
17	No use	18	GND
19	No use	20	W_DISABLE#
21	GND	22	PERST#
23	PCIE20_RXN	24	+3.3VSB
25	PCIE20_RXP	26	GND
27	GND	28	+1.5V
29	GND	30	SMB_CLK
31	PCIE20_TXN	32	SMB_DATA
33	PCIE20_TXP	34	GND
35	GND	36	USBP_10N
37	GND	38	USBP_10P
39	+3.3VSB	40	GND
41	+3.3VSB	42	No use
43	GND	44	No use
45	No use	46	No use
47	No use	48	+1.5V
49	No use	50	GND
51	No use	52	+3.3VSB

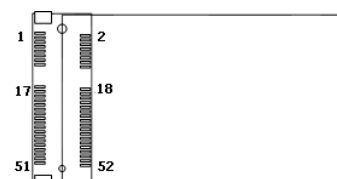

**CN12**

Pins	Signals	Pins	Signals
1	WAKE#	2	+3.3VSB
3	No use	4	GND
5	No use	6	+1.5V
7	No use	8	SIM S1_PWR
9	GND	10	SIM S1_I/O
11	REFCLK-	12	SIM S1_CLK
13	REFCLK+	14	SIM S1_RST
15	GND	16	SIM S1_VPP
17	No use	18	GND
19	No use	20	W_DISABLE#
21	GND	22	PERST#
23	PCIE19_RXN	24	+3.3VSB
25	PCIE19_RXP	26	GND
27	GND	28	+1.5V
29	GND	30	SMB_CLK
31	PCIE19_TXN	32	SMB_DATA
33	PCIE19_TXP	34	GND
35	GND	36	USB_D8-
37	GND	38	USB_D8+
39	+3.3VSB	40	GND
41	+3.3VSB	42	No use
43	GND	44	No use
45	No use	46	No use
47	No use	48	+1.5V
49	No use	50	GND
51	No use	52	+3.3VSB

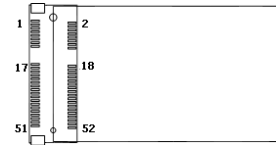



### 3.3.17 Half-Size Mini Card Slot (CN15 & CN16)

CN15 applies to PCI-Express and SATA (mSATA) signals and complies with PCI-Express Mini Card Spec. V1.2. Thus, users can install an mSATA card into this slot. Please refer to chapter 3.2 DIP Switch Mode.

CN16 only applies to USB 2.0 signals and complies with PCI-Express Mini Card Spec. V1.2.

#### CN15

Pins	Signals	Pins	Signals
1	WAKE#	2	+3.3VSB
3	No use	4	GND
5	No use	6	+1.5V
7	No use	8	No use
9	GND	10	No use
11	REFCLK-	12	No use
13	REFCLK+	14	No use
15	GND	16	No use
17	No use	18	GND
19	No use	20	W_DISABLE#
21	GND	22	PERST#
23	PCIE18_RXN/ mSATA5_RXN	24	+3.3VSB
25	PCIE18_RXP/ mSATA5_RXP	26	GND
27	GND	28	+1.5V
29	GND	30	SMB_CLK
31	PCIE18_TXN/ mSATA5_TXN	32	SMB_DATA
33	PCIE18_TXP/ mSATA5_TXP	34	GND
35	GND	36	USB_D8-
37	GND	38	USB_D8+
39	+3.3VSB	40	GND
41	+3.3VSB	42	No use
43	GND	44	No use
45	No use	46	No use
47	No use	48	+1.5V
49	No use	50	GND
51	No use	52	+3.3VSB

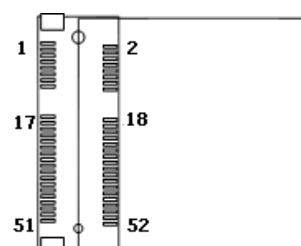

**CN16**

Pins	Signals	Pins	Signals
1	WAKE#	2	+3.3VSB
3	No use	4	GND
5	No use	6	+1.5V
7	No use	8	No use
9	GND	10	No use
11	No use	12	No use
13	No use	14	No use
15	GND	16	No use
17	No use	18	GND
19	No use	20	W_DISABLE#
21	GND	22	PERST#
23	No use	24	+3.3VSB
25	No use	26	GND
27	GND	28	+1.5V
29	GND	30	SMB_CLK
31	No use	32	SMB_DATA
33	No use	34	GND
35	GND	36	USBP_11N
37	GND	38	USBP_11N
39	+3.3VSB	40	GND
41	+3.3VSB	42	No use
43	GND	44	No use
45	No use	46	No use
47	No use	48	+1.5V
49	No use	50	GND
51	No use	52	+3.3VSB

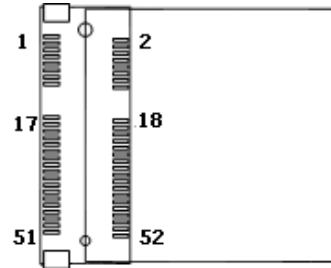

## SECTION 4

# BIOS SETUP UTILITY

This section provides users with detailed descriptions in terms of how to set up basic system configurations through the BIOS setup utility.

### 4.1 Starting

To enter the setup screens, follow the steps below:

1. Turn on the computer and press the <Del> key immediately.
2. After press the <Del> key, the main BIOS setup menu displays. Users can access to other setup screens, such as the Advanced and Chipset menus, from the main BIOS setup menu.

It is strongly recommended that users should avoid changing the chipset's defaults. Both AMI and system manufacturer have carefully set up these defaults that provide the best performance and reliability.

### 4.2 Navigation Keys

The BIOS setup/utility uses a key-based navigation system called hot keys. Most of the BIOS setup utility hot keys can be used at any time during the setup navigation process. These keys include <F1>, <F2>, <Enter>, <ESC>, <Arrow> keys, and so on.



**【Note】** : *Some of the navigation keys differ from one screen to another.*

Hot Keys	Descriptions
→← Left/Right	The Left and Right <Arrow> keys allow users to select a setup screen.
↑↓ Up/Down	The Up and Down <Arrow> keys allow users to select a setup screen or sub-screen.
+– Plus/Minus	The Plus and Minus <Arrow> keys allow users to change the field value of a particular setup item.
Tab	The <Tab> key allows users to select setup fields.
F1	The <F1> key allows users to display the General Help screen.
F2	The <F2> key allows users to Load Previous Values.
F3	The <F3> key allows users to Load Optimized Defaults.
F4	The <F4> key allows users to save any changes they made and exit the Setup. Press the <F4> key to save any changes.
Esc	The <Esc> key allows users to discard any changes they made and exit the Setup. Press the <Esc> key to exit the setup without saving any changes.
Enter	The <Enter> key allows users to display or change the setup option listed for a particular setup item. The <Enter> key can also allow users to display the setup sub- screens.

### 4.3 Main Menu

The Main Menu screen is the first screen users see when entering the setup utility. Users can always return to the Main setup screen by selecting the Main tab. System Time/Date can be set up as described below. The Main BIOS setup screen is also shown below.



#### BIOS Information

Display the auto-detected BIOS information.

#### System Language

Choose the system default language.

#### System Date/Time

Use this option to change the system time and date. Highlight System Time or System Date using the <Arrow> keys. Enter new values through the keyboard. Press the <Tab> key or the <Arrow> keys to move between fields. The date must be entered in MM/DD/YY format. The time is entered in HH:MM:SS format.

#### Access Level

Display the access level of current user.

## 4.4 Advanced Menu

The Advanced menu also allows users to set configuration of the CPU and other system devices. Users can select any items in the left frame of the screen to go to sub menus:

- ▶ ACPI Settings
- ▶ CPU Configurations
- ▶ NCT6106D Super IO Configurations
- ▶ NCT6106D HW Monitor
- ▶ SATA Configurations
- ▶ PCH-FW Configurations
- ▶ USB Computing
- ▶ Utility Configurations
- ▶ NCT6106D DIO Configurations
- ▶ PoE Configurations

For items marked with “▶”, please press <Enter> for more options.

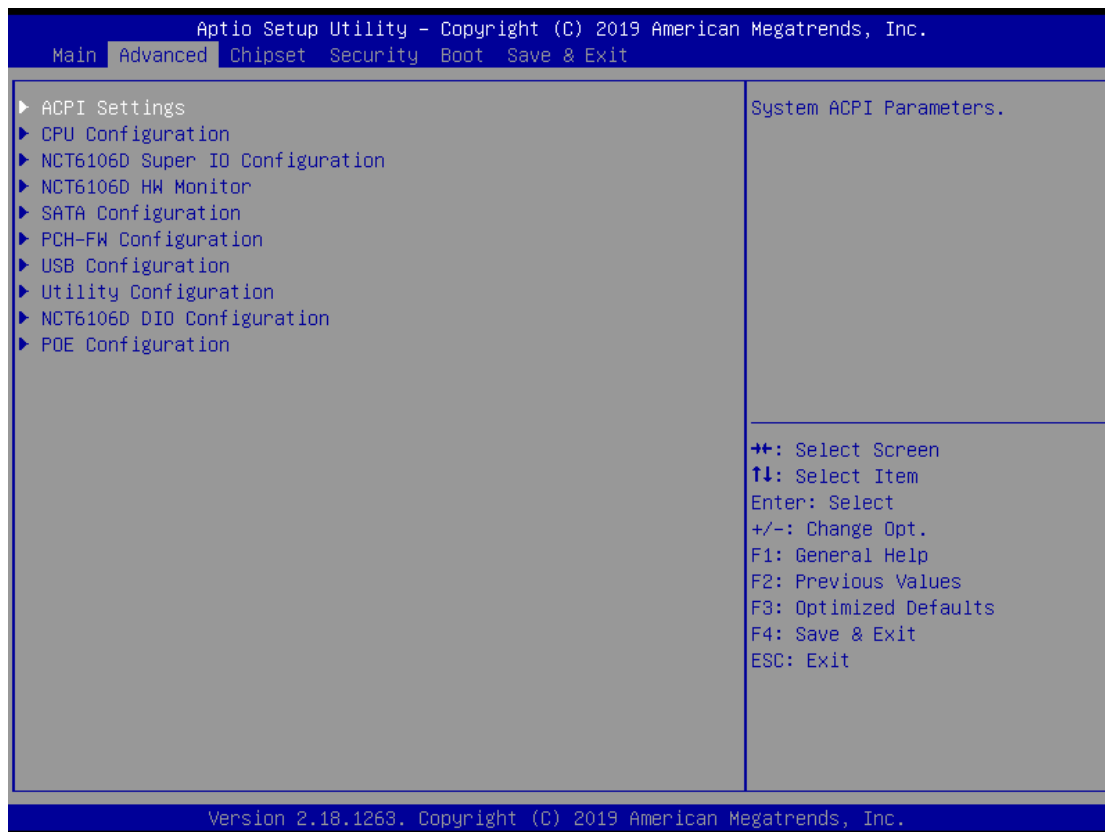

### **ACPI Settings**

Use this screen to select options for the ACPI configuration, and change the value of the selected option. A description of the selected item appears on the right side of the screen.

### **ACPI Sleep State**

When the sleep button is pressed, the system will be in the ACPI sleep state.

The default is S3 (Suspend to RAM).

## CPU Configurations

This screen shows the CPU version and its detailed information.

```

Aptio Setup Utility - Copyright (C) 2019 American Megatrends, Inc.
  Advanced
CPU Configuration
Type                Intel(R) Core(TM)
                   i7-6700TE CPU @ 2.40GHz
ID                 0x506E3
Microcode Revision C2
Speed              2400 MHz
L1 Data Cache      32 KB x 4
L1 Instruction Cache 32 KB x 4
L2 Cache           256 KB x 4
L3 Cache           8 MB
L4 Cache           N/A
VMX                Supported
SMX/TXT            Supported

Hyper-Threading    [Enabled]
Intel (VMX) Virtualization Technology [Enabled]

Enabled for Windows XP and Linux (OS optimized for Hyper-Threading Technology) and Disabled for other OS (OS not optimized for Hyper-Threading Technology).

++: Select Screen
↑↓: Select Item
Enter: Select
+/-: Change Opt.
F1: General Help
F2: Previous Values
F3: Optimized Defaults
F4: Save & Exit
ESC: Exit

Version 2.18.1263. Copyright (C) 2019 American Megatrends, Inc.

```

### Intel Virtualization Technology

It allows a hardware platform to run multiple operating systems separately and simultaneously, enabling one system to virtually function as several systems.

## NCT6106D Super IO Configurations

Use this screen to select options for the NCT6106D Super IO Configurations, and change the value of the selected option. A description of the selected item appears on the right side of the screen. For items marked with “ ”, please press <Enter> for more options

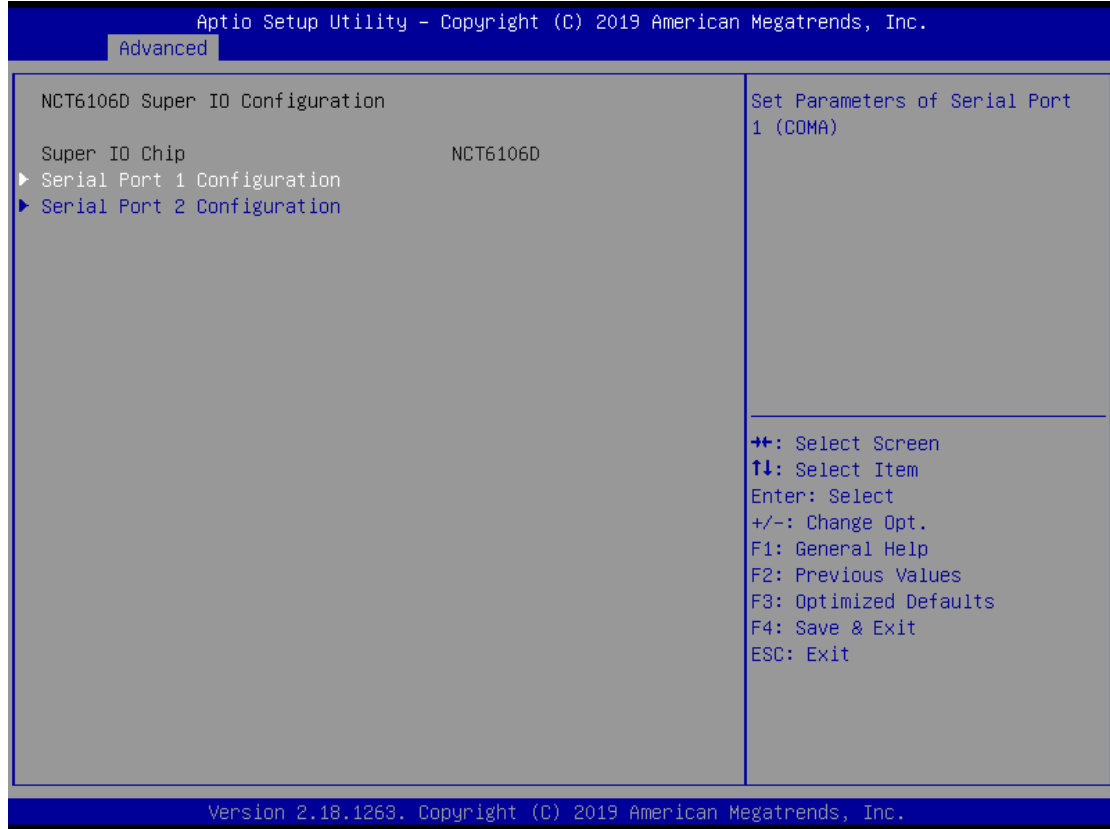

## Serial Port 1~2 (COM1~2) Configurations

Use these items to set parameters related to serial ports 1~2. Default is RS-232 mode.



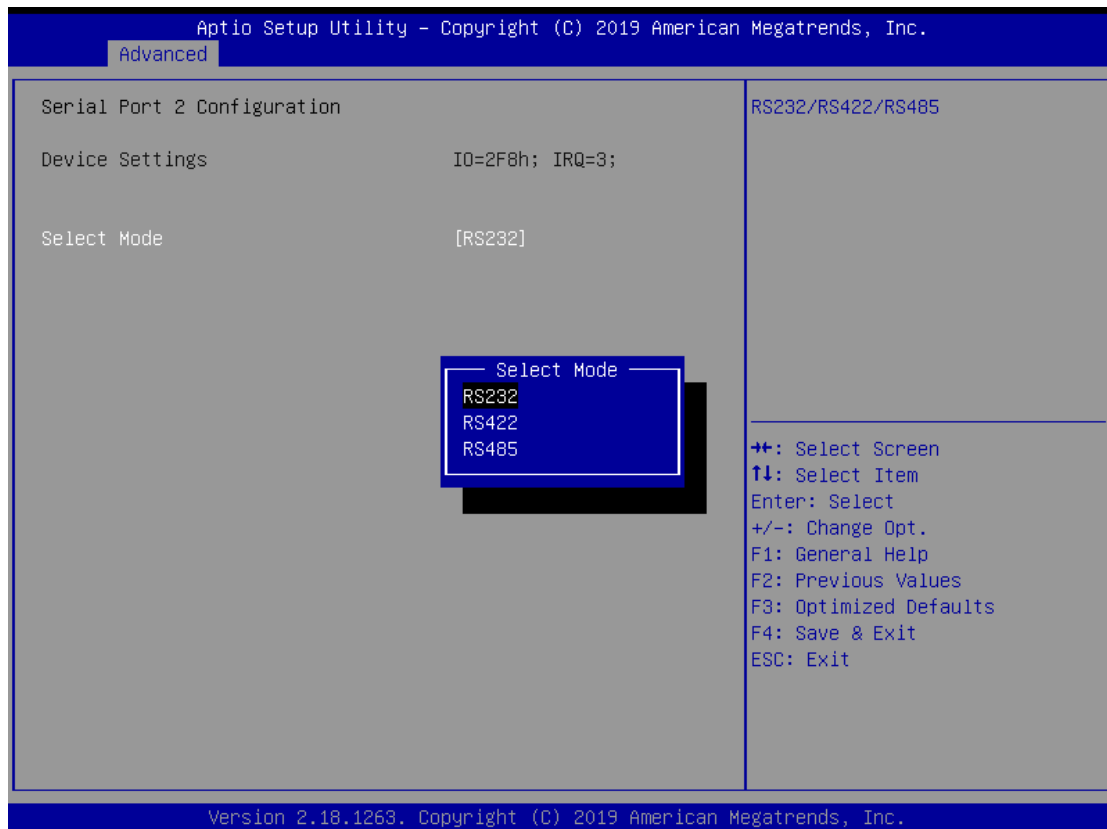
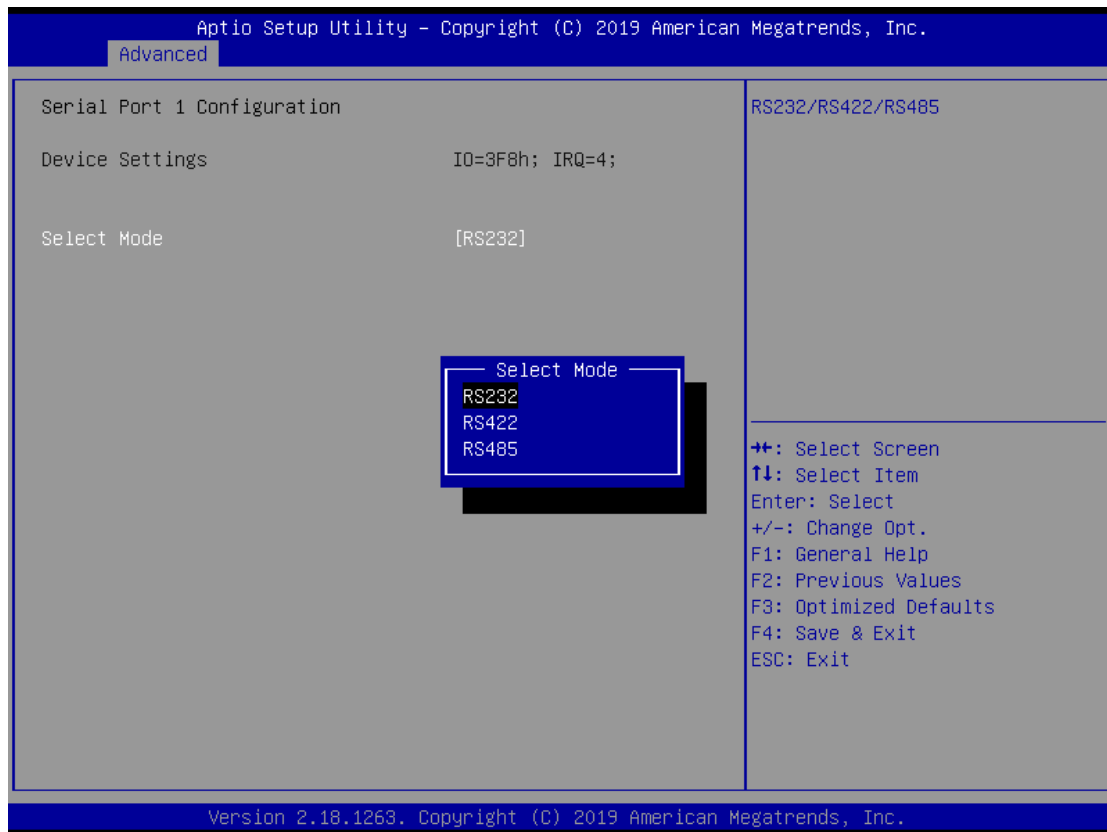

### NCT6106D HW Monitor

This screen displays the temperature of system and CPU and system voltages (VCORE, +3.3V, +12V and +5V).

The screenshot shows the 'Advanced' tab of the Aptio Setup Utility. The main content area is titled 'Pc Health Status' and displays the following data:

CPU	: +44 °C
SYSTEM	: +27 °C
VCORE	: +0.976 V
+3.3V	: +3.328 V
+5V	: +5.120 V
+3.3VSB	: +3.280 V
+5VSB	: +5.088 V
VBAT	: +2.768 V

Navigation instructions are listed in the bottom right corner:

- ⇐: Select Screen
- ↑↓: Select Item
- Enter: Select
- +/-: Change Opt.
- F1: General Help
- F2: Previous Values
- F3: Optimized Defaults
- F4: Save & Exit
- ESC: Exit

At the bottom of the screen, the text reads: 'Version 2.18.1263. Copyright (C) 2019 American Megatrends, Inc.'

## SATA Configurations

In this Configuration menu, you can see the currently installed hardware in the SATA ports. During system boot up, the BIOS automatically detects the presence of SATA devices.

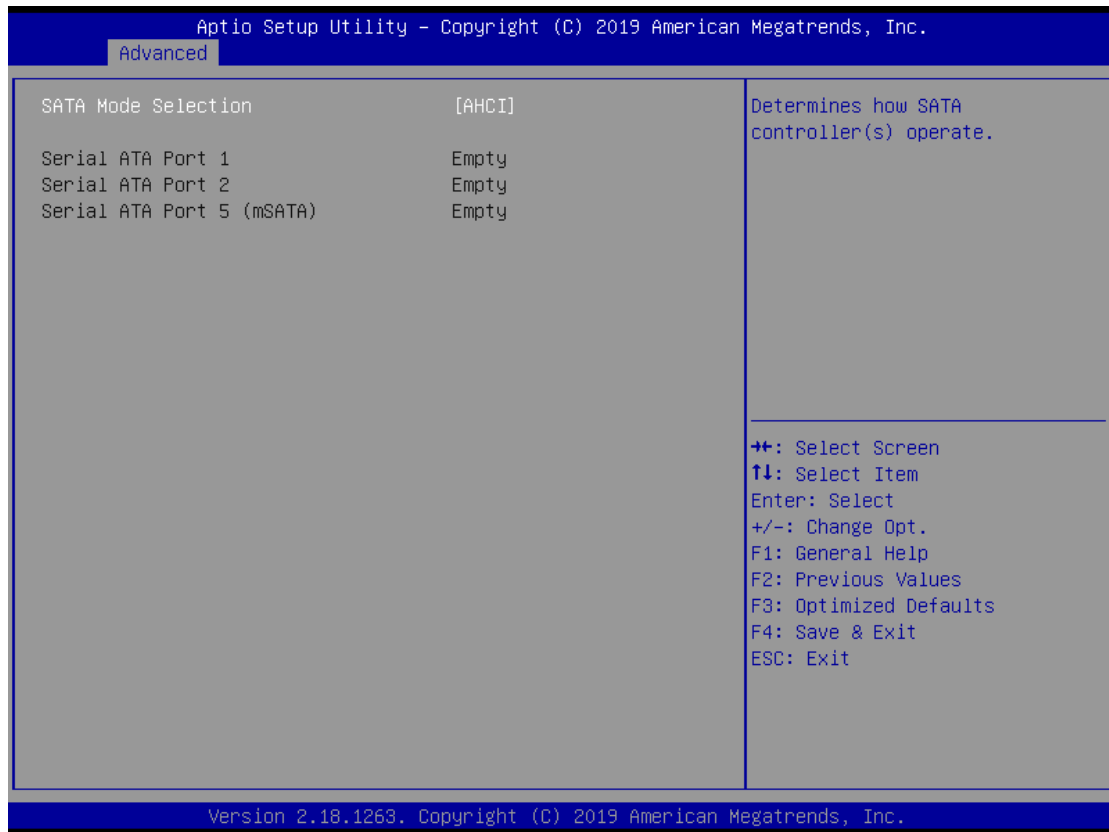

### SATA Mode Selection

AHCI (Advanced Host Controller Interface) mode is how SATA controller(s) operate.

### Serial ATA Port 1/2/5

It shows the device installed in connector SATA1/2/5, SATA5 belongs to mSATA.

## PCH-FW Configuration

This screen shows ME Firmware information.

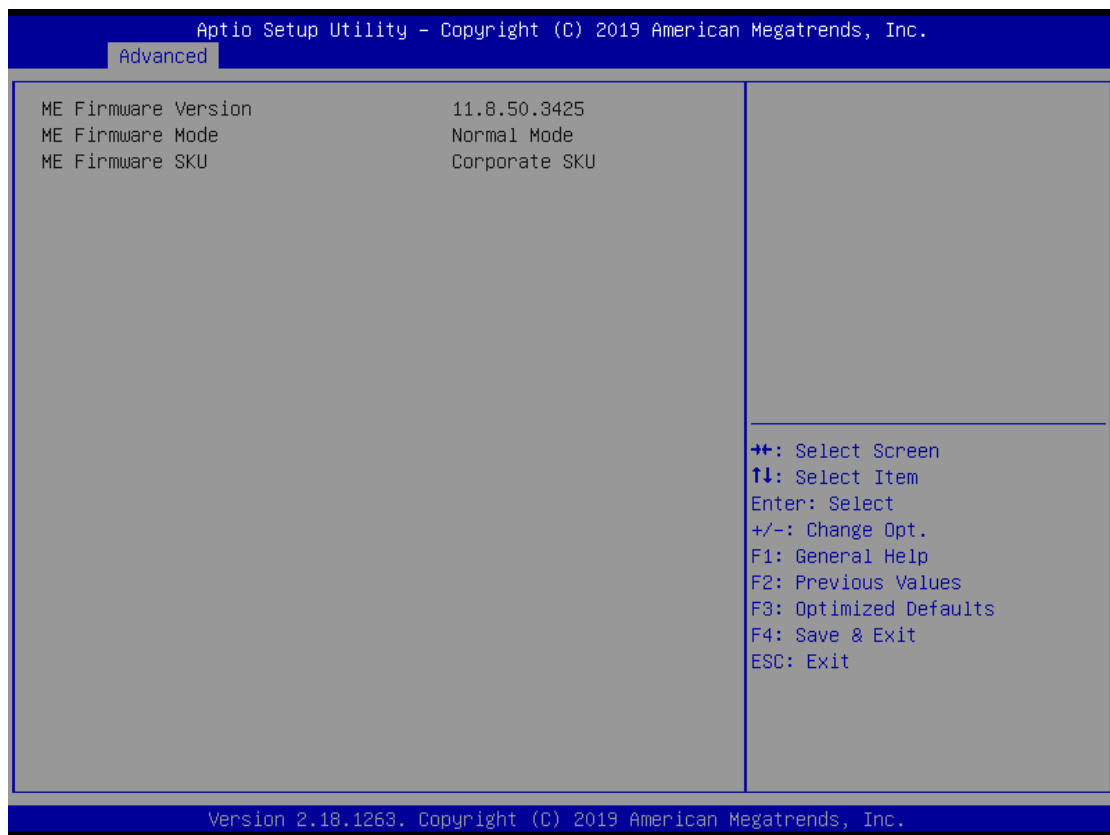

## USB Configurations

Aptio Setup Utility - Copyright (C) 2019 American Megatrends, Inc.	
Advanced	
USB Configuration	Mass storage device emulation type. 'AUTO' enumerates devices according to their media format. Optical drives are emulated as 'CDROM', drives with no media will be emulated according to a drive type.
USB Module Version	17
USB Controllers:	
1 XHCI	
USB Devices:	
1 Drive, 1 Keyboard, 1 Mouse	
Mass Storage Devices:	
KingstonDataTraveler 2.06.16	[Auto]
	++: Select Screen ↑↓: Select Item Enter: Select +/-: Change Opt. F1: General Help F2: Previous Values F3: Optimized Defaults F4: Save & Exit ESC: Exit
Version 2.18.1263. Copyright (C) 2019 American Megatrends, Inc.	

## USB Devices

Display all detected USB devices.

## Utility Configurations

Base on this page to setup BIOS flash utility and related functions.

BIOS flash utility is a tool for flash BIOS on setup menu. Follow the step to flash BIOS.

1. Create a folder and rename on the root of USB storage (Ex: X:\)
2. Copy the BIOS file to the folder (Ex: X:\ \SBC87517X.005)

(Note : The BIOS file name must contain the word SBC87517)

3. Enter the BIOS flash utility and locate the BIOS file
4. Push "Start flash system BIOS"



## BIOS Flash Utility

The screenshot displays the BIOS Flash Utility interface. At the top, it reads "Aptio Setup Utility - Copyright (C) 2019 American Megatrends, Inc." and "Advanced". The main area is split into two panes. The left pane, titled "Utility Configuration", shows "BIOS Flash Utility" selected. The right pane, titled "BIOS Flash Utility", is currently empty. A dialog box titled "Select File from a File system" is open in the center, showing the path "Acpi(a0341d0, 0)\PCI(14|0)\USB(3,0)\HD(Part1, Sig ?)\". Below the dialog, a "Screen" menu lists the following options: "↑↓: Select Item", "Enter: Select", "+/-: Change Opt.", "F1: General Help", "F2: Previous Values", "F3: Optimized Defaults", "F4: Save & Exit", and "ESC: Exit". The bottom of the screen displays "Version 2.18.1263. Copyright (C) 2019 American Megatrends, Inc."

## NCT6106D DIO Configurations

Use this screen to display DIO polarity and level.

The screenshot shows the 'Advanced' menu of the Aptio Setup Utility. The title bar reads 'Aptio Setup Utility - Copyright (C) 2019 American Megatrends, Inc.' and the current menu is 'Advanced'. The main content area is titled 'NCT6106D DIO Configuration' and lists the status of eight DIO pins. A legend on the right side of the screen explains the navigation keys: double arrows for selecting a screen, up/down arrows for selecting an item, Enter for selecting, +/- for changing options, F1 for general help, F2 for previous values, F3 for optimized defaults, F4 for save and exit, and ESC for exit. The footer of the screen displays 'Version 2.18.1263. Copyright (C) 2019 American Megatrends, Inc.'

NCT6106D DIO Configuration	
DIO 0 Input/Output Status	Output Low
DIO 1 Input/Output Status	Output Low
DIO 2 Input/Output Status	Input High
DIO 3 Input/Output Status	Input High
DIO 4 Input/Output Status	Input High
DIO 5 Input/Output Status	Input High
DIO 6 Input/Output Status	Input High
DIO 7 Input/Output Status	Input High

Legend:

- ↔: Select Screen
- ↑↓: Select Item
- Enter: Select
- +/-: Change Opt.
- F1: General Help
- F2: Previous Values
- F3: Optimized Defaults
- F4: Save & Exit
- ESC: Exit

Version 2.18.1263. Copyright (C) 2019 American Megatrends, Inc.



## PoE Configurations

Use this screen to select options for the PoE configuration -CH  
PoE, users can base on this screen to adjust their PoE setting. The default PoE power budget is 90W. A description of the selected item appears on the right side of the screen. For items marked with “▶”, please press <Enter> for more options.

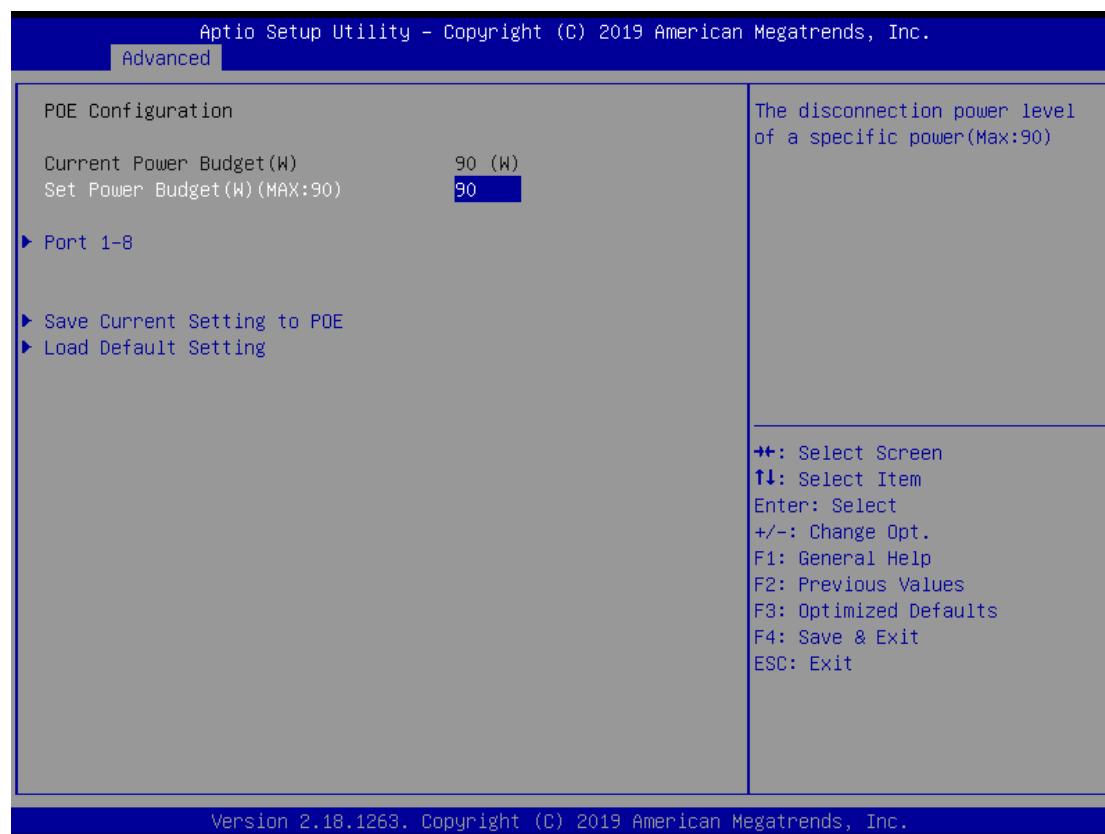

### Current Power Budget

Display current total power budget on all ports.

### Set Power Budget

Set disconnection power level of a specific power.

### Save Current Setting to POE

Save the current setting from menu into the POE non-volatile memory and these user values become the defaults after any reset.

### Load Default Setting

Restore to default setting and save to POE, Default : Power Budget 90w, all ports enabled.

### PoE Port 1 ~ 8

Use this screen to enable or disable 8-CH PoE ports, users can adjust each PoE ports.

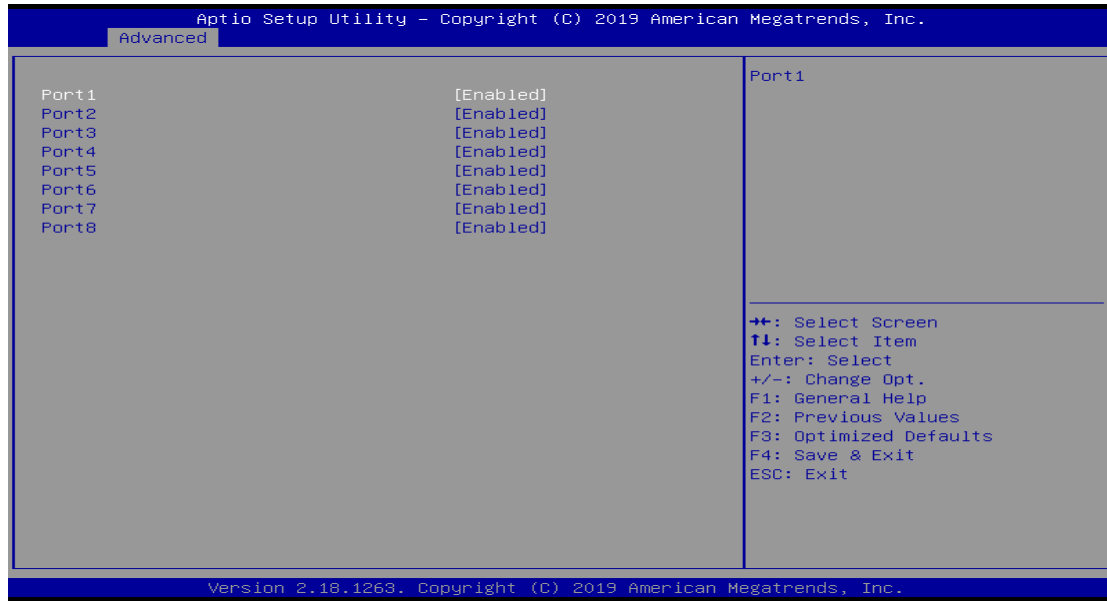

## 4.5 Chipset Menu

The Chipset menu allows users to change the advanced chipset settings. Users can select any of the items in the left frame of the screen to go to the sub menus:

### ▶ System Agent (SA) Configurations

For items marked with “▶”, please press <Enter> for more options.

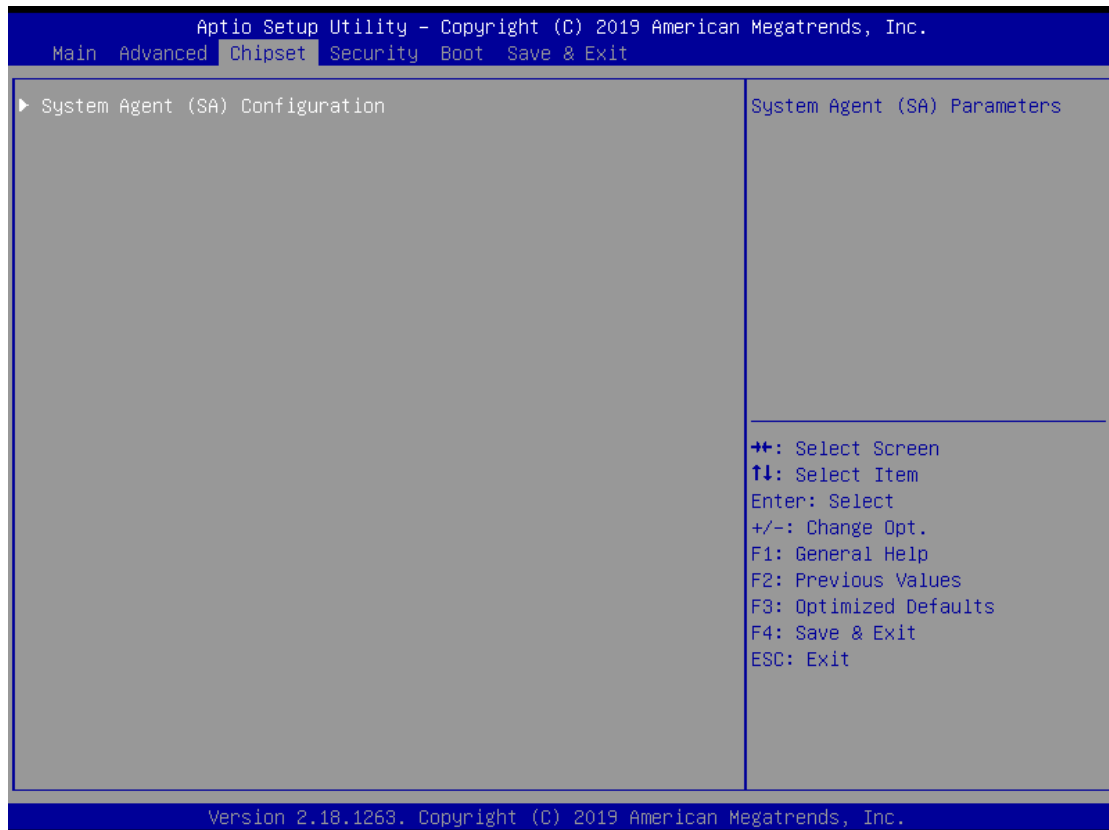

## System Agent (SA) Configurations

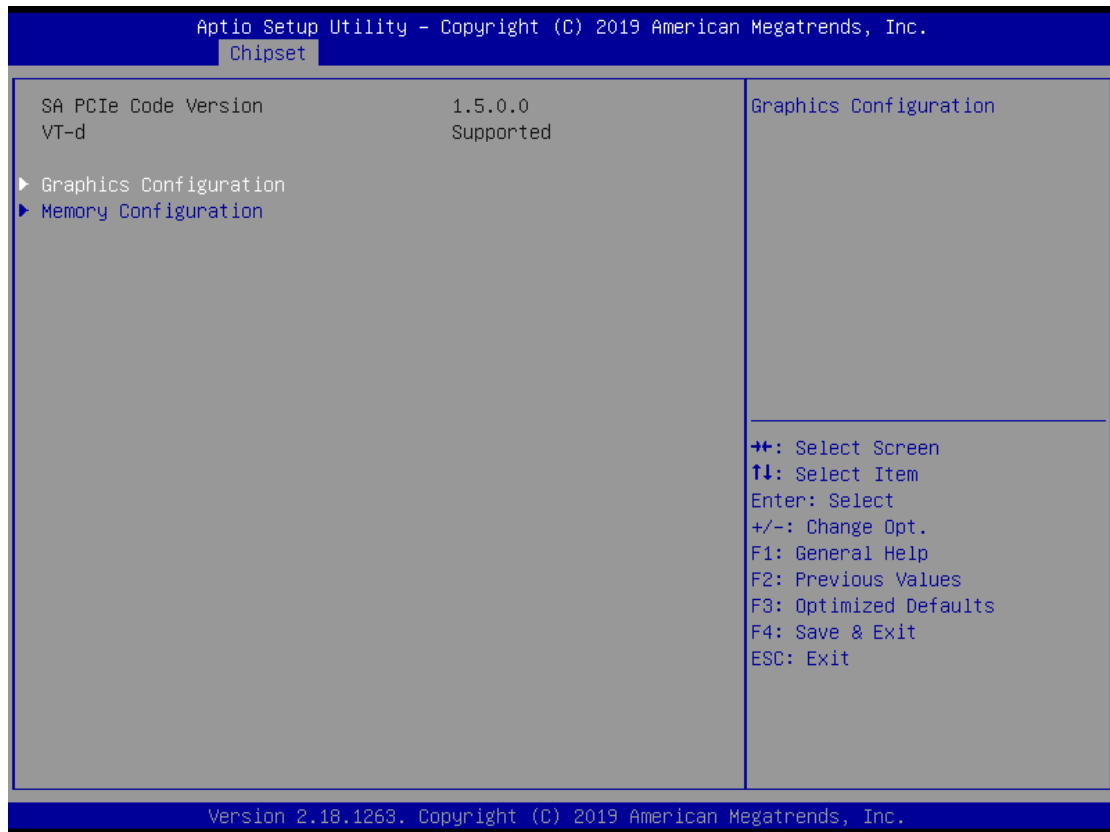

### Graphics Configuration

Use this item to configure internal graphics controller.

### Memory Configuration

Use this item to refer to the information related to system memory.

## Graphic Configurations

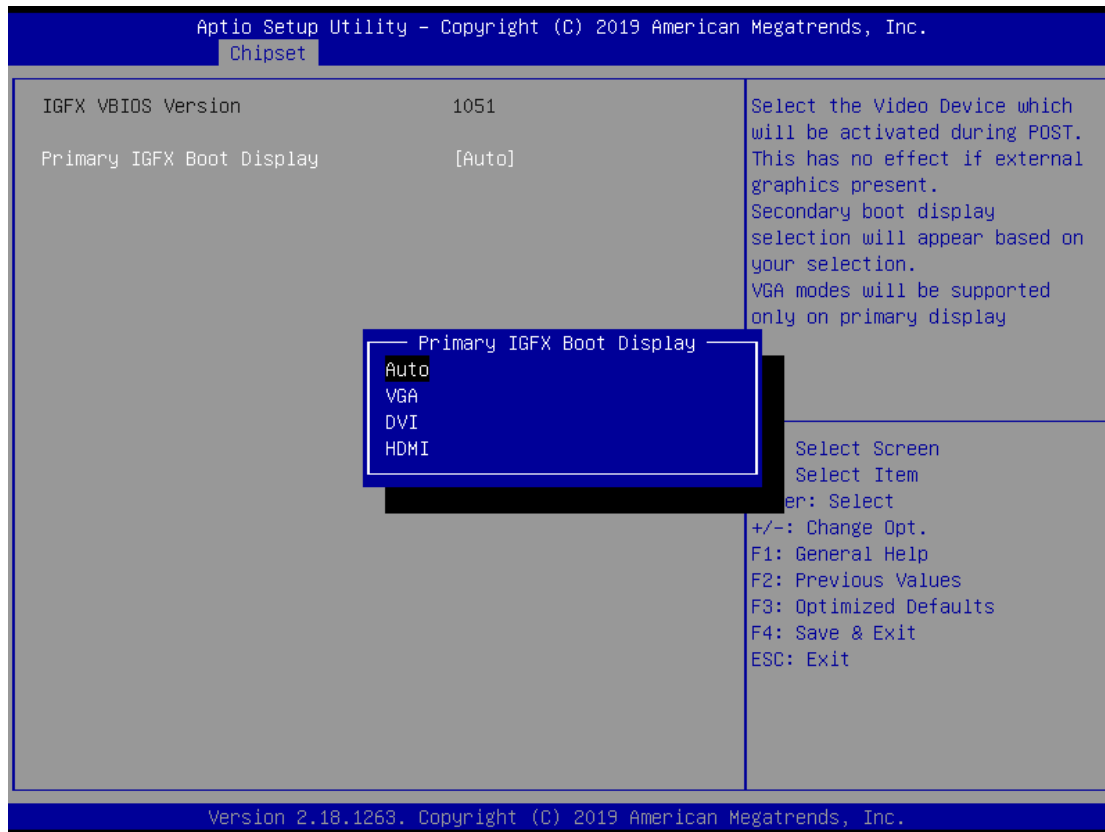

### Primary IGFX Boot Display

Select the video device which will be activated during POST (Power-On Self-Test). The default is HDMI (ONBOARD). The image above shows option list in Primary IGFX Boot Display when no I/O board is installed.

## Memory Configurations

This screen shows the system memory information.

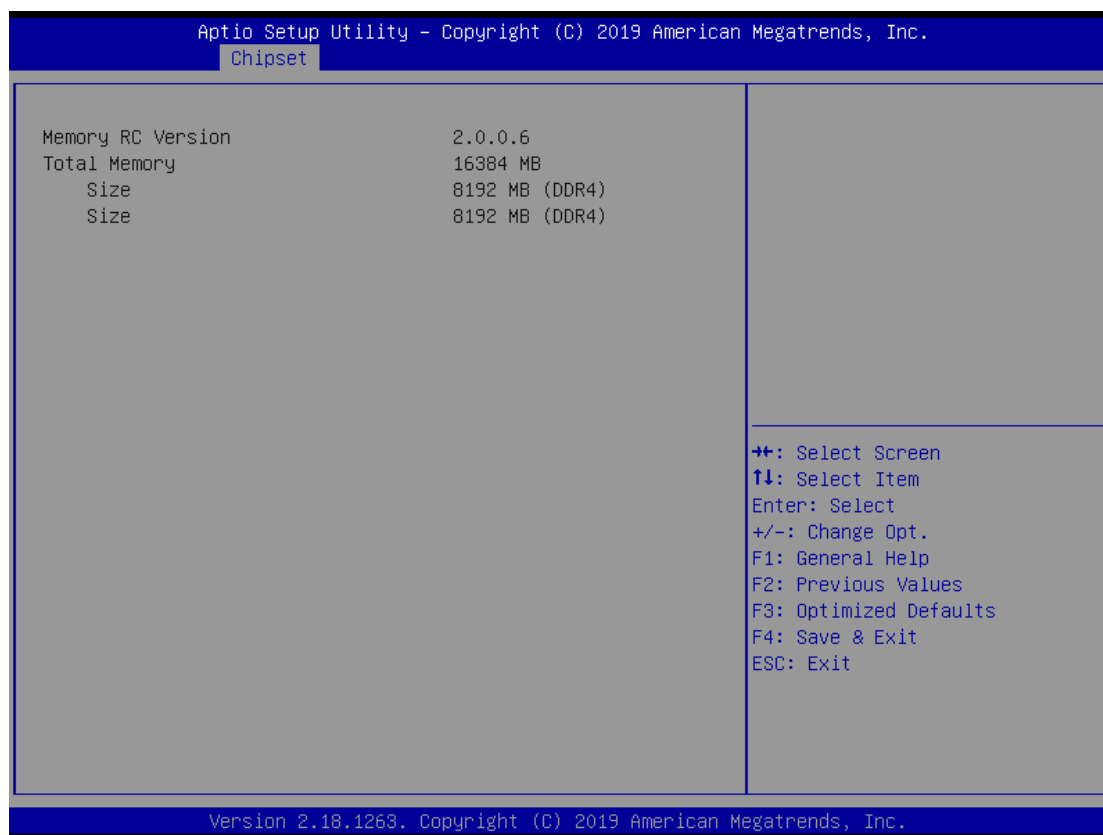

## Security Menu

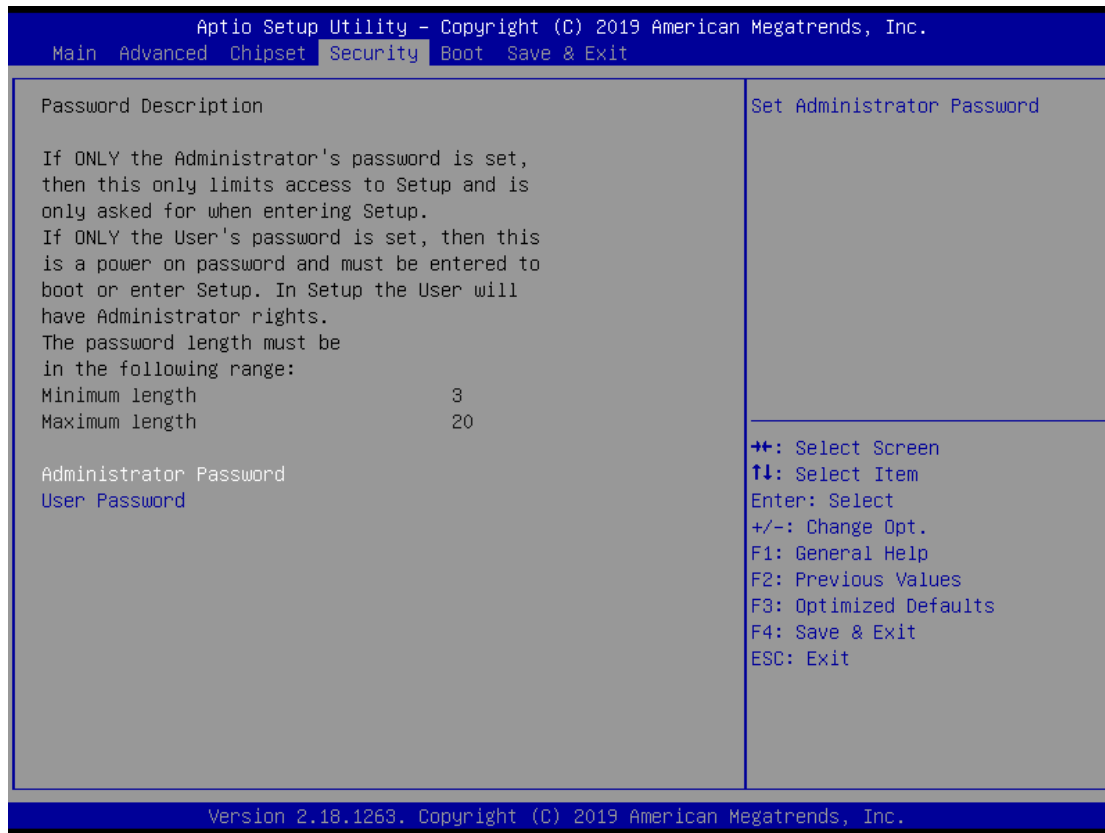

### Administrator Password

This item indicates whether an administrator password has been set (installed or uninstalled).

### User Password

This item indicates whether a user password has been set (installed or uninstalled).

## 4.6 Boot Menu

The Boot menu allows users to change boot options of the system.

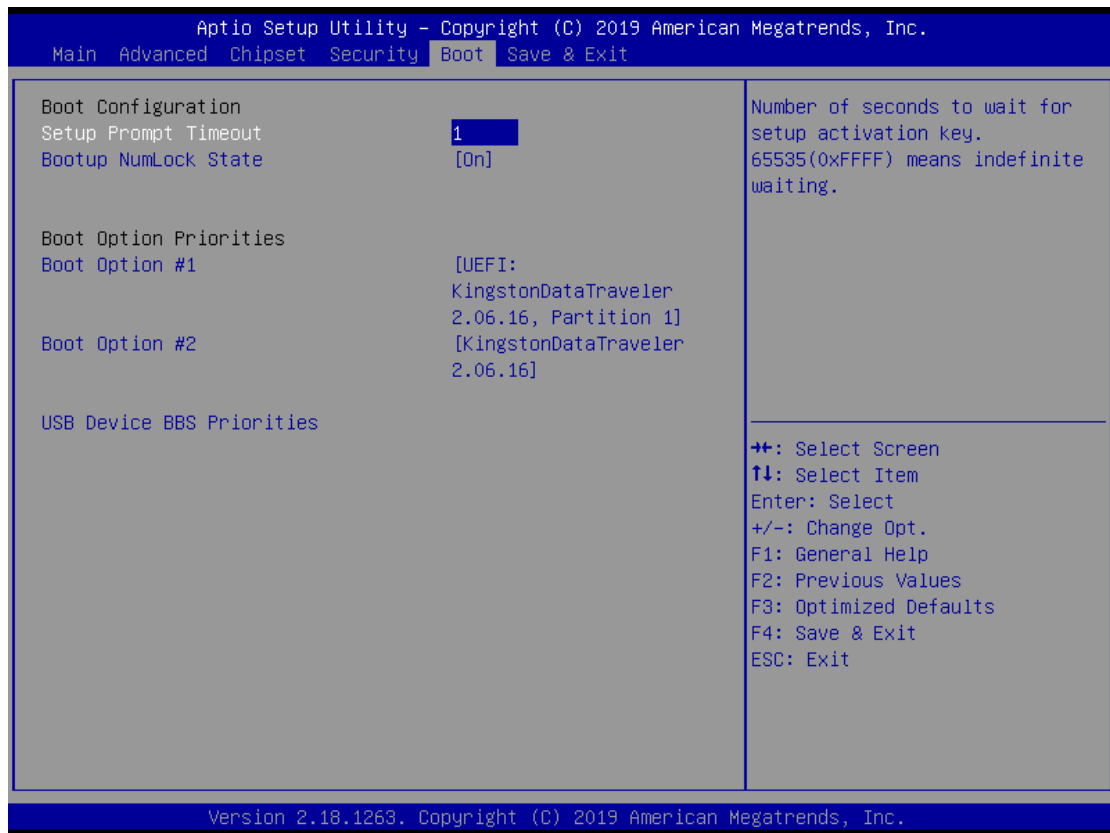

### Setup Prompt Timeout

Use this item to set up number of seconds to wait for setup activation key where 65535(0xFFFF) means indefinite waiting.

### Bootup NumLock State

Use this item to select the power-on state for the keyboard NumLock.

### Boot Option Priorities

These are settings for boot priority. Specify the boot device priority sequence from the available devices.



## 4.7 Save & Exit Menu

The Save & Exit menu allows users to load system configurations with optimal or fail-safe default values.



### Save Changes and Exit

When users have completed the system configuration changes, select this option to leave Setup and return to Main Menu. Select Save Changes and Exit from the Save & Exit menu and press <Enter>. Select Yes to save changes and exit.

### Discard Changes and Exit

Select this option to quit Setup without making any permanent changes to the system configurations and return to Main Menu. Select Discard Changes and Exit from the Save & Exit menu and press <Enter>. Select Yes to discard changes and exit.

### Save Changes and Reset

When completed the system configuration changes, select this option to leave Setup and reboot the computer so the new system configurations take effect. Select Save Changes and Reset from the Save & Exit menu and press <Enter>. Select Yes to save changes and reset.

### Discard Changes and Reset

Select this option to quit Setup without making any permanent changes to the system configuration and reboot the computer. Select Discard Changes and Reset from the Save & Exit menu and press <Enter>. Select Yes to discard changes and reset.

### **Save Changes**

When completed the system configuration changes, select this option to save changes. Select Save Changes from the Save & Exit menu and press <Enter>. Select Yes to save changes.

### **Discard Changes**

Select this option to quit Setup without making any permanent changes to the system configurations. Select Discard Changes from the Save & Exit menu and press <Enter>. Select Yes to discard changes.

### **Restore Defaults**

It automatically sets all Setup options to a complete set of default settings when users select this option. Select Restore Defaults from the Save & Exit menu and press <Enter>.

### **Save as User Defaults**

Select this option to save system configuration changes done so far as User Defaults. Select Save as User Defaults from the Save & Exit menu and press <Enter>.

### **Restore User Defaults**

It automatically sets all Setup options to a complete set of User Defaults when users select this option. Select Restore User Defaults from the Save & Exit menu and press <Enter>.

### **Boot Override**

Select a drive to immediately boot that device regardless of the current boot order.

## APPENDIX A WATCHDOG TIMER

### About Watchdog Timer

Software stability is a major issue in most applications. Some embedded systems are not watched by humans for 24 hours. It is usually too slow to wait for someone to reboot when a computer hangs. The system needs to be able to reset automatically when things go wrong. The watchdog timer gives us solutions in this regard.

The watchdog timer is a counter that triggers a system to reset when it counts down to zero from a preset value. The software starts the counter with an initial value and must reset it periodically. If the counter ever reaches zero, it means the software has crashed, the system will reboot.

### Sample Program

The following example enables configurations using debug tool.

#### Enable Watchdog timer

STEP	Sample code	Note
1. Enter configuration mode	0 2E 87	Un-lock super I/O
	0 2E 87	Un-lock super I/O
2. Select logic device	0 2E 07	Select logic register
	0 2F 08	Switch to WDT device
3. Enable WDT device	0 2E 30	Select register
	0 2F 01	Enable WDT
4. Set time unit	0 2E F0	Select logic register
	0 2F M	M = 08h (Minute) , M = 00h (Second)
5. Set timer	0 2E F1	Select logic register
	0 2F 0A	Set timer (where 0A (hex) = 10sec)

**Disable Watchdog timer**

<b>STEP</b>	<b>Sample code</b>	<b>Note</b>
1. Enter configuration mode	0 2E 87	Un-lock super I/O
	0 2E 87	Un-lock super I/O
2. Select logic device	0 2E 07	Select logic register
	0 2F 08	Switch to WDT device
3. Disable WDT device	0 2E 30	Select register
	0 2F 00	Disable WDT

## APPENDIX B DIGITAL I/O

### Digital I/O Specification

#### Digital Input:

Input channels: 6, sink/source type

Input voltage: 0 to 30VDC at 25Hz

Input level for dry contacts:

Logic level 0: close to ground

Logic level 1: open

Input level for wet contacts:

Logic level 1: +/-3VDC max.

Logic level 0: +/- 10VDC min. to +/-30VDC max. (source to digital input)

#### Digital output:

output channels: 2, sink type

output current: 200mA max. per channel

on-state voltage: 12~ 24VDC nominal

Isolation: 3.75 KV

Max voltage on COM+: 30VDC

### Digital I/O Software Programming

- Super IO GPIO4 Group, Location: Address F1h
- GPIO40~41 is output,GPIO42~47 is input

#### CR F1h. GPIO4 Data Register

Location: Address F1h

Attribute: Read/Write

Power Well: VSB

Reset by: GP4X\_MRST

Default : 00h

Size: 8 bits

BIT	READ / WRITE	DESCRIPTION
7-0	R / W	GPIO4 Data register For output ports, the respective bits can be read/written and produced to pins.

## Digital Input Wiring

### DRY contact

Logic level 0: close to ground  
Logic level 1: open

### DRY

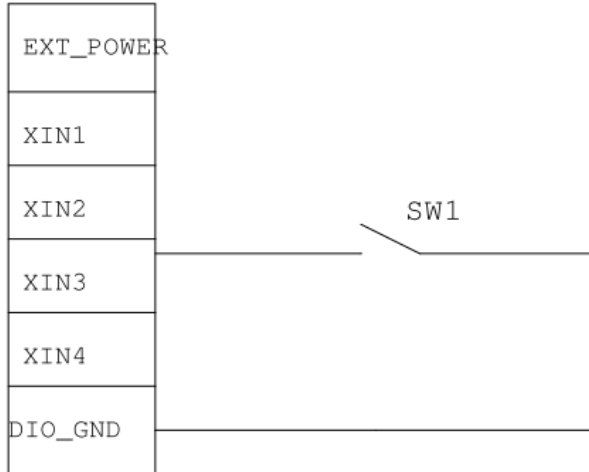

### WET contact

Logic level 1: +/-3VDC max.  
Logic level 0: +/- 10VDC min. to +/-30VDC max

### WET

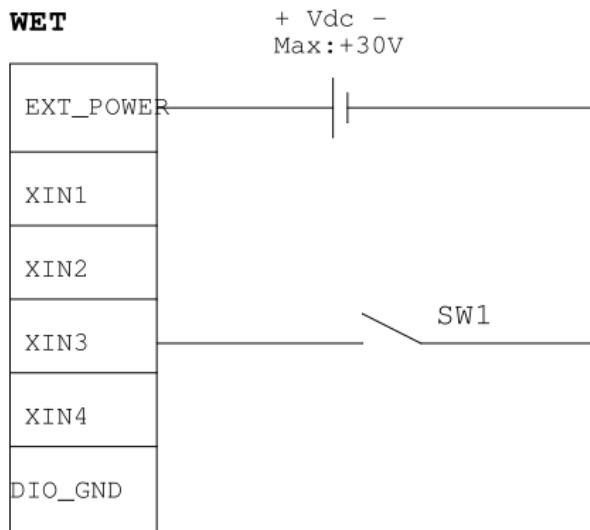

## Digital Output Wiring

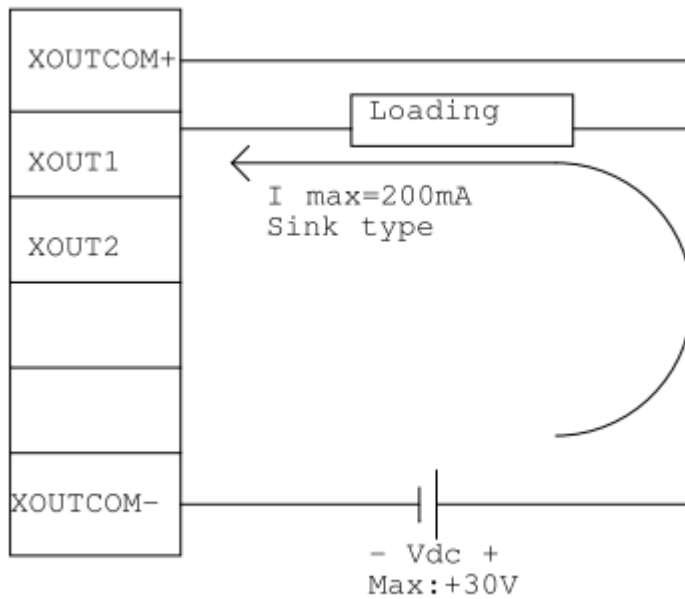

## About Programmable Digital I/O

4DI or 2DO. Please refer to Driver CD for sample code and demo tool.



**【Note】** DIO Status Bit1~2 are DO. When select it, can check DO active low.

**LED bit1** correspond to front side P0 LED,

**LED bit2** correspond to front side P1 LED, When select it, can check LED off.

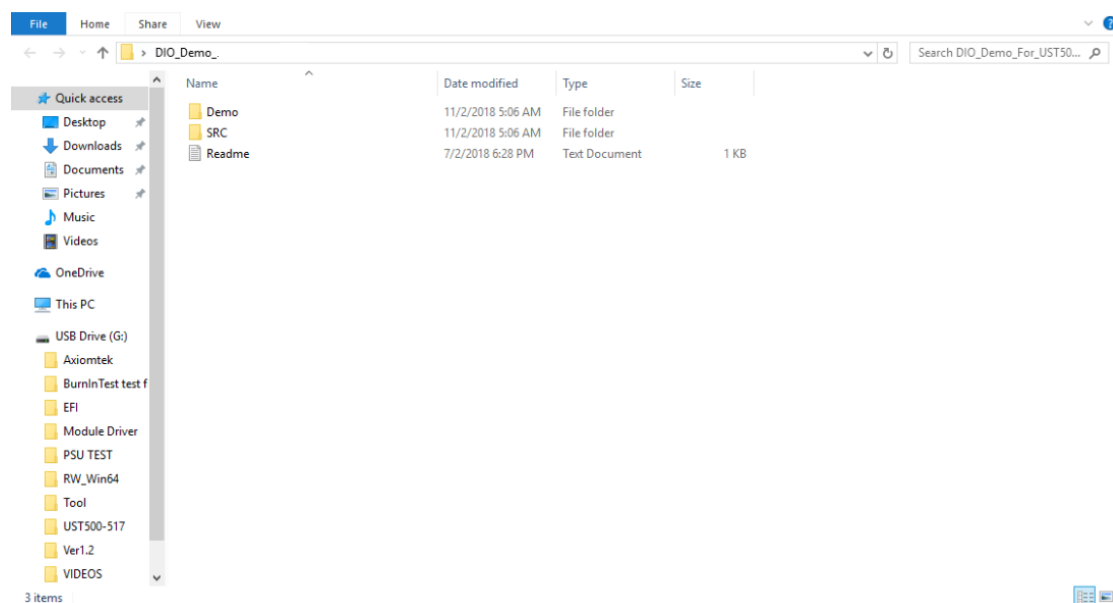

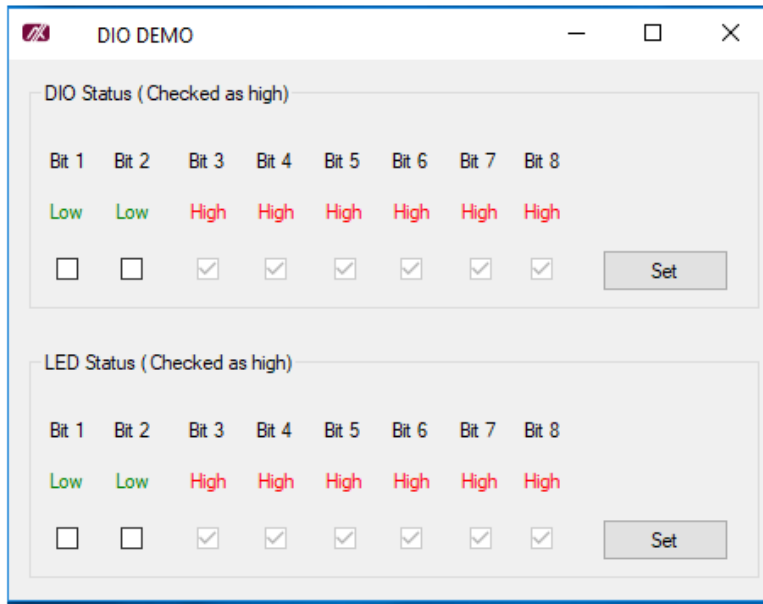



## **APPENDIX C CONFIGURING SATA FOR RAID**

### **Configuring SATA Hard Drive(s) for RAID (Controller: Intel® Q170)**

Before you begin the SATA configuration, please prepare four SATA hard drives (to ensure optimal performance, it is recommended that you use two hard drives with the identical model and capacity). If you do not want to create RAID with the SATA controller, you may prepare only one hard drive.

**Please follow the steps below to configure SATA hard drive(s):**

1. Install SATA hard drive(s) in your system.
2. Enter the BIOS Setup to configure SATA controller mode and boot sequence.
3. Configure RAID using the RAID BIOS.

#### **1. Installing SATA hard drive(s) in your system.**

Connect one end of the SATA signal cable to the rear of the SATA hard drive, and the other end to an available SATA port on the board. Then, connect the power connector of power supply to the hard drive.

#### **2. Configuring SATA controller mode and boot sequence by the BIOS Setup.**

You have to make sure whether the SATA controller is configured correctly by system BIOS Setup and set up BIOS boot sequence for the SATA hard drive(s).

- 2.1. Turn on your system, and then press the <Del> button to enter BIOS Setup during running POST (Power-On Self-Test). If you want to create RAID, just go to the Advanced Settings menu\SATA Configuration, select the “SATA Mode Selection”, and press <Enter> for more options.

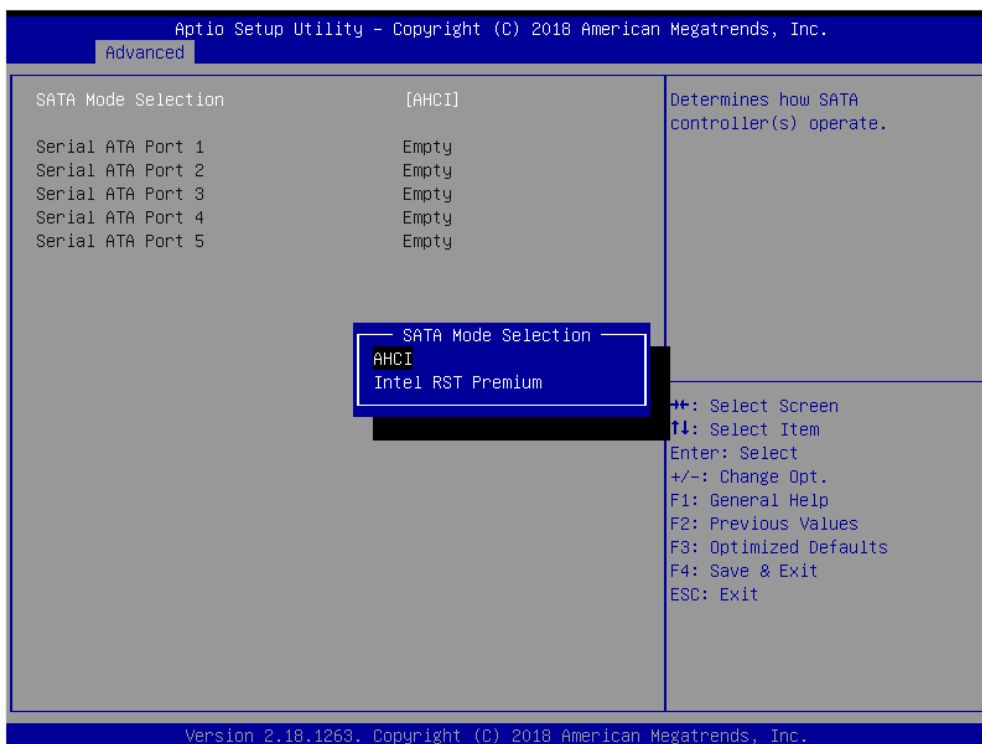

A list of options appears. Please select “Intel RST Premium”.

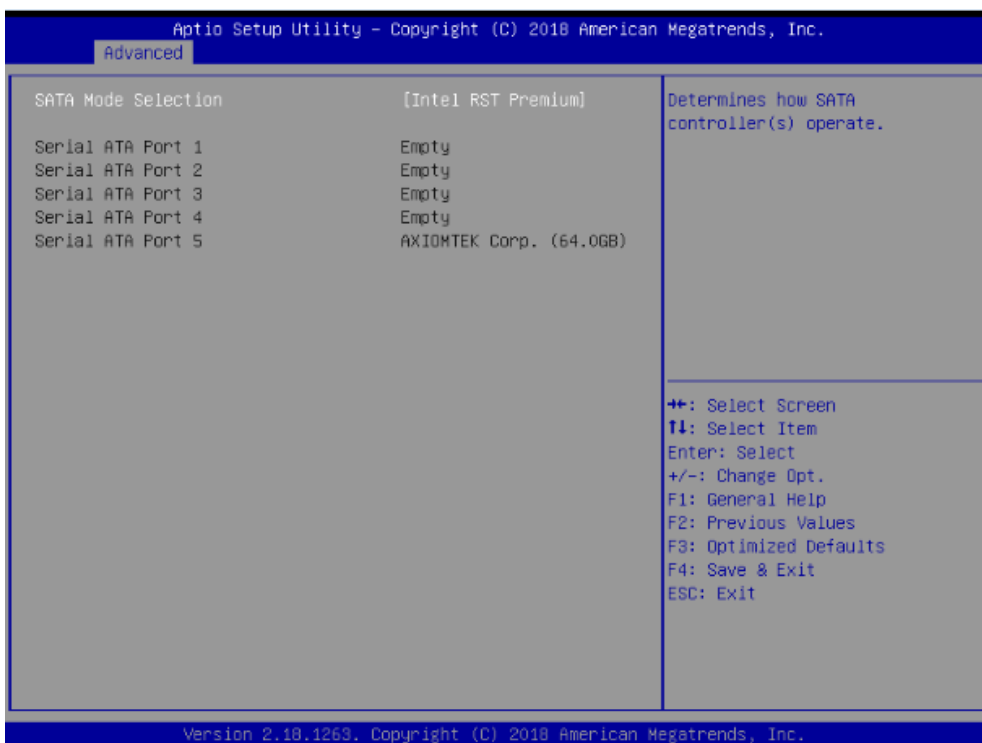

- 2.2. Save and exit the BIOS Setup.

### 3. Configuring RAID by the RAID BIOS.

Enter the RAID BIOS setup utility to configure a RAID array. Skip this step and proceed if you do not want to create a RAID.

- 3.1. After the POST memory testing and before the operating system booting, a message "Press <Ctrl-I> to enter Configuration Utility" shows up. Press <Ctrl + I> to enter the RAID BIOS setup utility.

```

Intel(R) Rapid Storage Technology - Option ROM - 15.2.0.2740
Copyright(C) 2003-13 Intel Corporation. All Rights Reserved.

RAID Volumes:
ID      Name          Level          Strip      Size  Status  Bootable
0       Volume1        RAID0(Stripe) 128KB     149.1GB Normal  Yes

Physical Devices:
ID      Device Model      Serial #      Size  Type/Status(Vol ID)
4       ST320LT012-9WS14 WOV20YPA     298.0GB Member Disk(0)
5       ST380817AS        5MR1BSS7     74.5GB  Member Disk(0)

Press <CTRL-I> to enter Configuration Utility...

```

- 3.2. After you press <Ctrl + I>, the Create RAID Volume screen will appear. If you want to create a RAID array, select the Create RAID Volume option in the Main Menu and press <Enter>.

```

Intel(R) Rapid Storage Technology - Option ROM - 15.2.0.2740
Copyright (C) Intel Corporation. All rights reserved.

[ MAIN MENU ]
1. Create RAID Volume
2. Delete RAID Volume
3. Reset Disks to Non-RAID
4. Recovery Volume Options
5. Acceleration Options
6. Exit

[ DISK/VOLUME INFORMATION ]

RAID Volumes:
None Defined.

Physical Devices:
ID      Device Model      Serial #      Size  Type/Status(Vol ID)
4       ST320LT012-9WS14 WOV20YPA     298.0GB Non-RAID Disk
5       ST380817AS        5MR1BSS7     74.5GB  Non-RAID Disk

[↑↓]-select      [ESC]-Exit      [Enter]-select Menu

```

- 3.3. After entering the Create Volume Menu screen, you can type the disk array name with 1~16 letters (letters cannot be special characters) in the item "Name:".

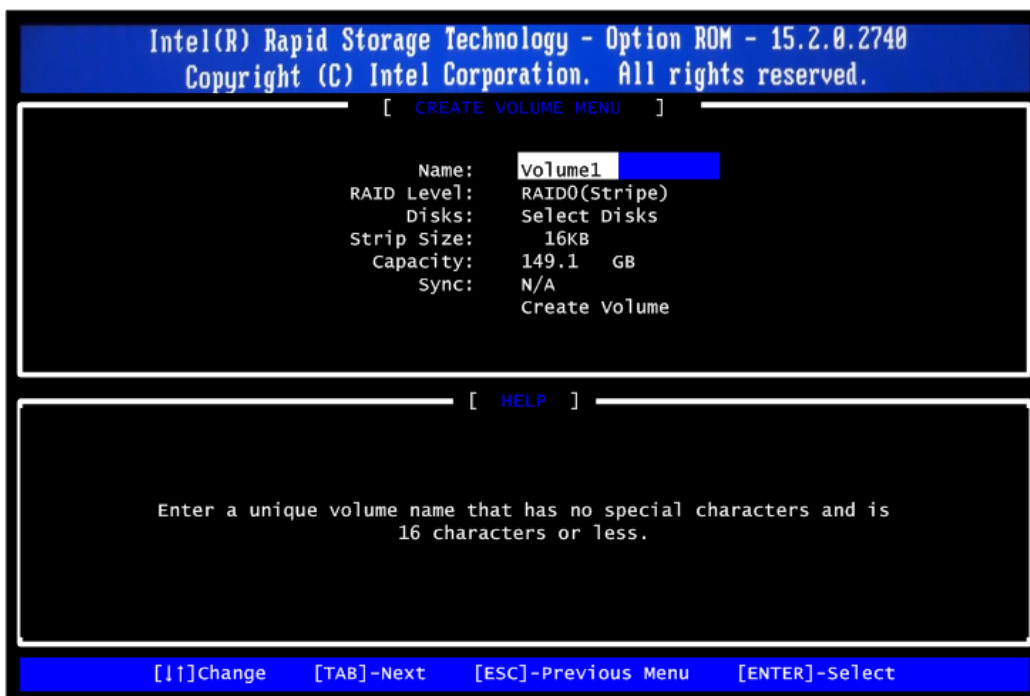

- 3.4. When finished, press <Enter> to select a RAID level. There are two RAID levels: RAID0, RAID1. Select a RAID level and press <Enter>.  
Note: -support RAID0, RAID1 Only.

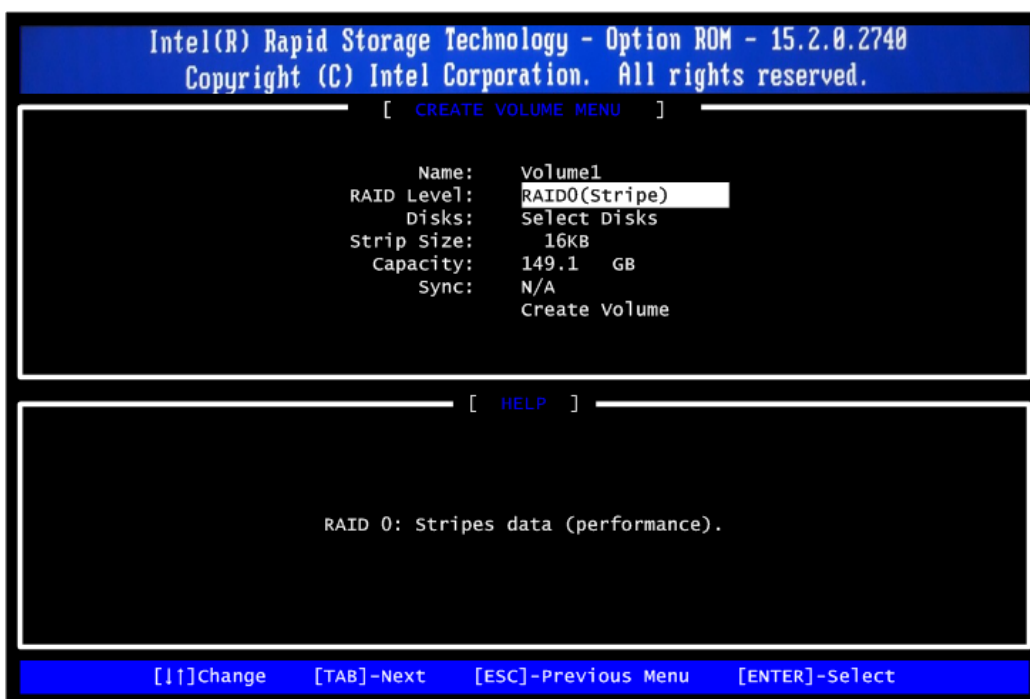

- 3.5. Set the stripe block size. The KB is the standard unit of stripe block size. The stripe block size can be 4KB to 128KB. After the setting, press <Enter> for the array capacity.



- 3.6. After setting all the items on the menu, select Create Volume and press <Enter> to start creating the RAID array.

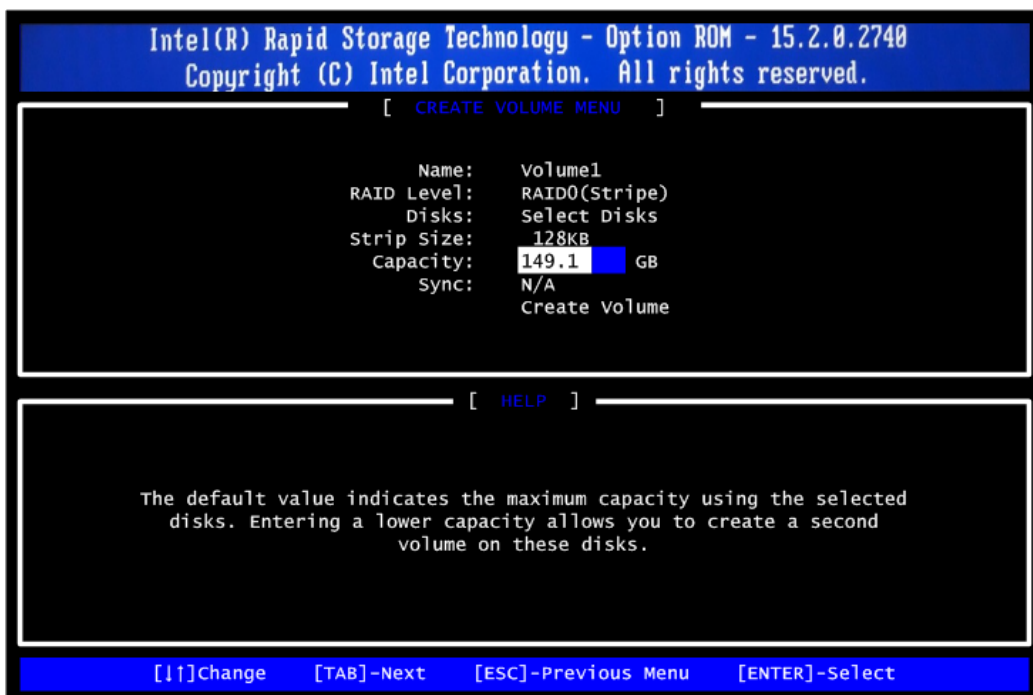

3.7. When prompting the confirmation, press <Y> to create this volume, or <N> to cancel the creation.

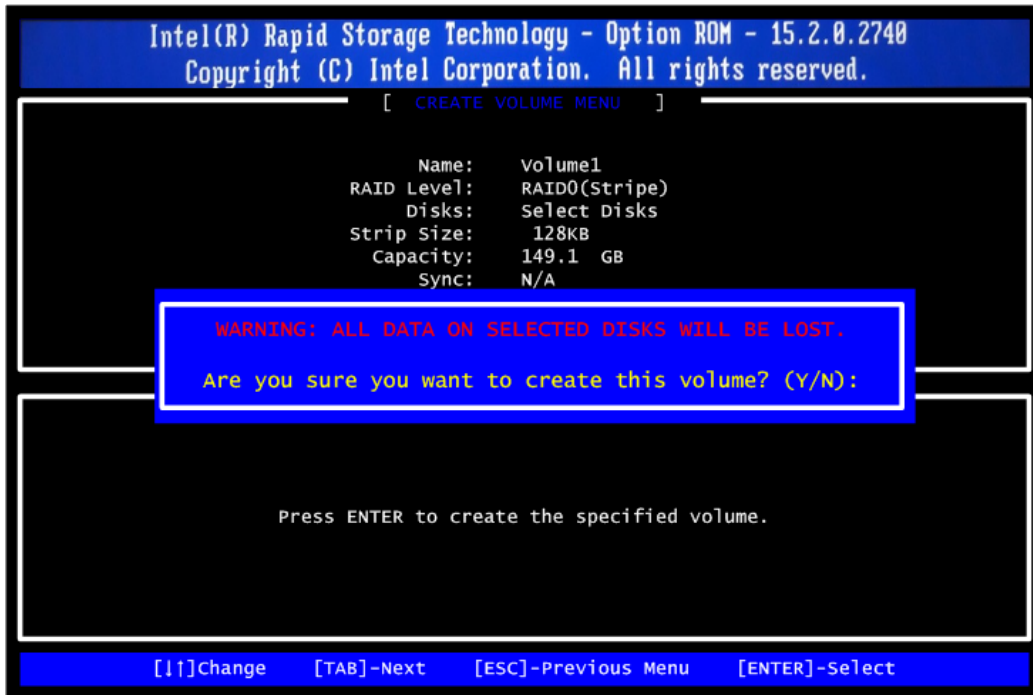

After the creation is completed, you will see detailed information about the RAID array in the Disk/Volume Information section, including RAID mode, disk block size, disk name, disk capacity, etc.

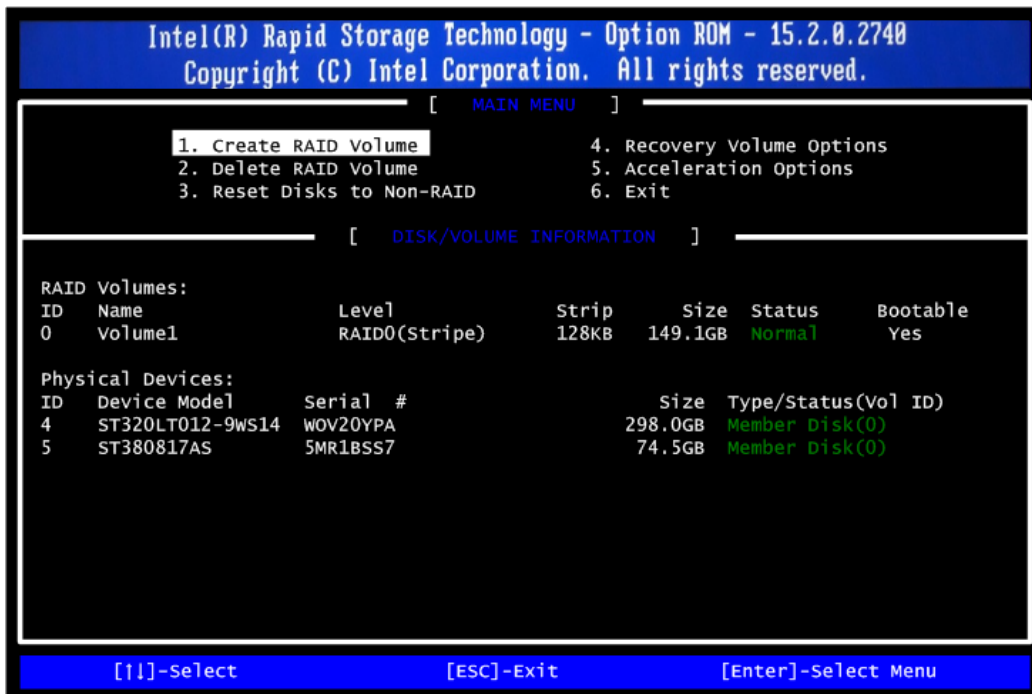

## Delete RAID volume

If you want to delete a RAID volume, select the Delete RAID Volume option in Main Menu. Press <Enter> and follow on-screen instructions.

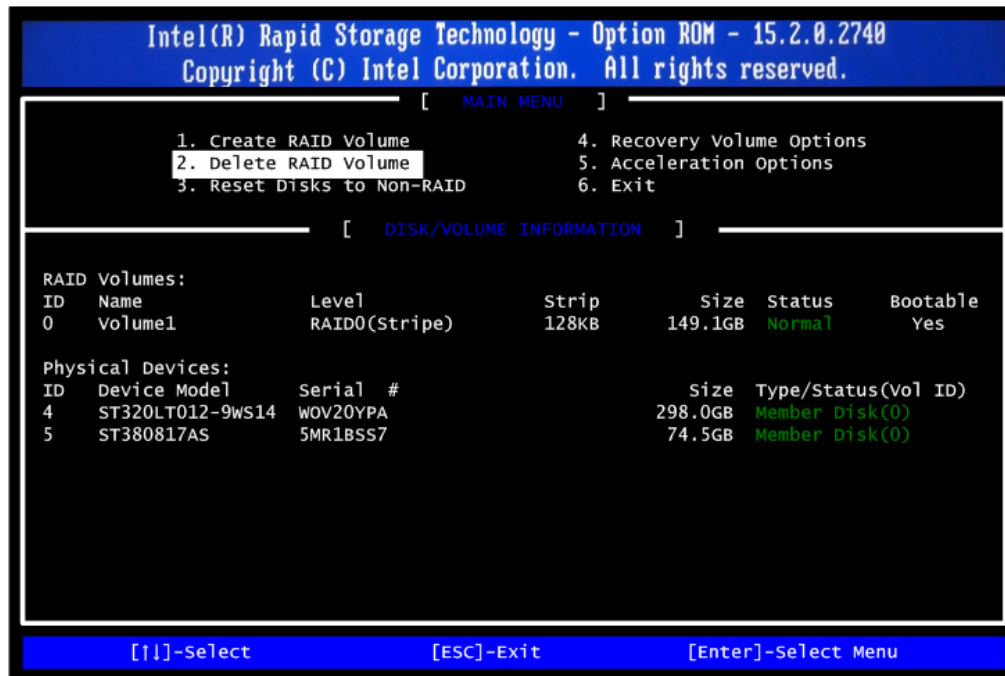

Please press <Esc> to exit the RAID BIOS utility. Now, you can proceed to install a SATA driver controller and the operating system.